

MASTECH[®]

M55215

High Voltage Insulation Tester User's Manual



CE

Contents

Contents	01
Optional Accessories	05
Safety Instructions	08
Danger	08
Measurement Categories	09
1. General Description	12
1.1 Product Introduction	12
1.2 Features	13
1.3 General Description of Test Methods	13
1.3.1 Test conditions	13
1.3.2 Test procedures	14
1.4 Names and Functions of Components	18
1.4.1 Front view	18
1.4.2 LCD Display-all Diagram	19
1.4.3 Back view	20
1.4.4 Operation panel	21
2. Preparations before the Test	23
2.1 Power Supply	23
2.1.1 Battery Installation/Replacement	23
2.2 Powering on/off	24
2.2.1 Powering on	24
2.2.2 Powering off	24
2.2.3 Auto powering off	24
2.3 Setting and checking date / time	24
2.3.1 Setting date and time	25

Contents

2.3.2 Checking date and time	25
2.4 Connecting meter probes	26
2.4.1 Operation procedures	26
2.5 Connecting the temperature sensor	26
2.5.1 Operation procedures	26
3. Test Methods	27
3.1 Checking before the Test	27
3.1.1 Checking procedures	27
3.2 Insulation resistance test	28
3.2.1 Start testing	29
3.2.2 Finishing a test	31
3.2.3 Review and delete the held data	31
3.2.4 Auto-discharging function	32
3.2.5 Reviewing other test data	33
3.2.6 Principle of insulation resistance test	33
3.2.7 Using GUARD terminal	34
3.3 Voltage test	35
3.3.1 Operation procedures for voltage measurements	35
3.4 Temperature test	37
3.4.1 Operation procedures for temperature tests	37
4. Advanced test functions	38
4.1 Use of the timer	38
4.1.1 Setting the timer / controlling insulation resistance test	38
4.1.2 Turning off the timer	39
4.1.3 Checking the preset timer	39

Contents

4.2 Displaying PI and DAR	39
4.2.1 Application of PI, DAR	39
4.2.2 Operation procedures	41
4.3 Temperature Compensation	42
4.3.1 Application	42
4.3.2 Applying temperature compensation	43
4.3.3 Exiting the mode of temperature compensation	44
4.4 Step-Voltage Measurement	44
4.4.1 Setting and managing step-voltage test	45
4.4.2 Reviewing test data at every step	46
4.4.3 Exiting the mode of step-voltage measurement	46
5. Saving test data (save function)	47
5.1 Saving test data	49
5.1.1 Manual recording	49
5.1.2 Log recording	50
5.2 Reviewing recorded data	53
5.2.1 Operation procedures	53
5.2.2 Mode of displaying for recorded data	53
5.2.3 Reviewing recorded data	53
5.3 Deleting data	57
5.3.1 Delete specified data	57
5.3.2 Deleting all data	57
6. Other Functions	58
6.1 Changing and checking the time interval for calculating PI	58
6.1.1 Changing the settings for time intervals	58

Contents

6.1.2 Checking the settings for time intervals	25
6.2 Changing and checking the applied time for step-voltage test	26
6.2.1 Changing the settings for time	26
6.2.2 Checking the settings for time	26
6.3 Entering temperature/humidity values measured with external thermometer/hygrometer	26
6.3.1 Entering and saving temperature and humidity values	27
6.3.2 Clearing the indication for saving temperature/humidity data	27
6.4 Communicating with a PC	27
6.4.1 Installing the PC software	28
6.4.2 Installing driver	29
6.4.3 Downloading data to PC / Configuring the tester	31
7. Specifications	31
7.1 Ordinary specifications	32
7.2 Test parameters	33
7.2.1 Insulation resistance test	33
7.2.2 Leak current test	34
7.2.3 Voltage test	35
7.2.4 Temperature test	35
8. Maintenance and Repair	37
8.1 Trouble shooting	37
8.2 Cleaning	38
8.3 Disposal	38
Attached Table	38

Checking upon Receiving

Upon receiving, please first carefully check the tester for any damage resulting from transportation. Usually the accessories, the control switches and the connection devices should be checked. Please contact your supplier in case there is any obvious damage or any malfunction.

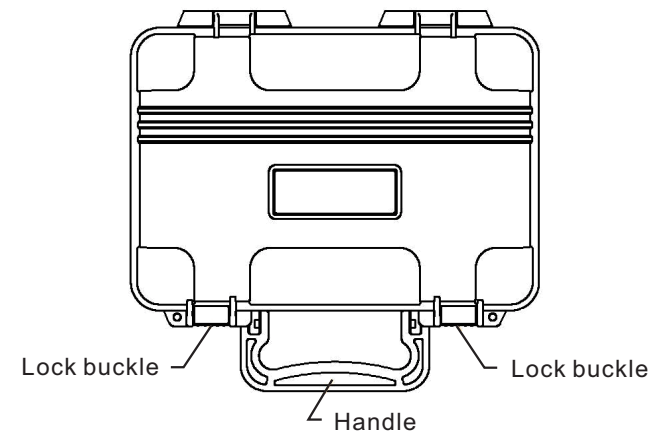
Procedures

1. Use your fingers to pull the lock buckle outward.
2. Lift the lock buckle upward so as to release the two buckles, and open the out case.

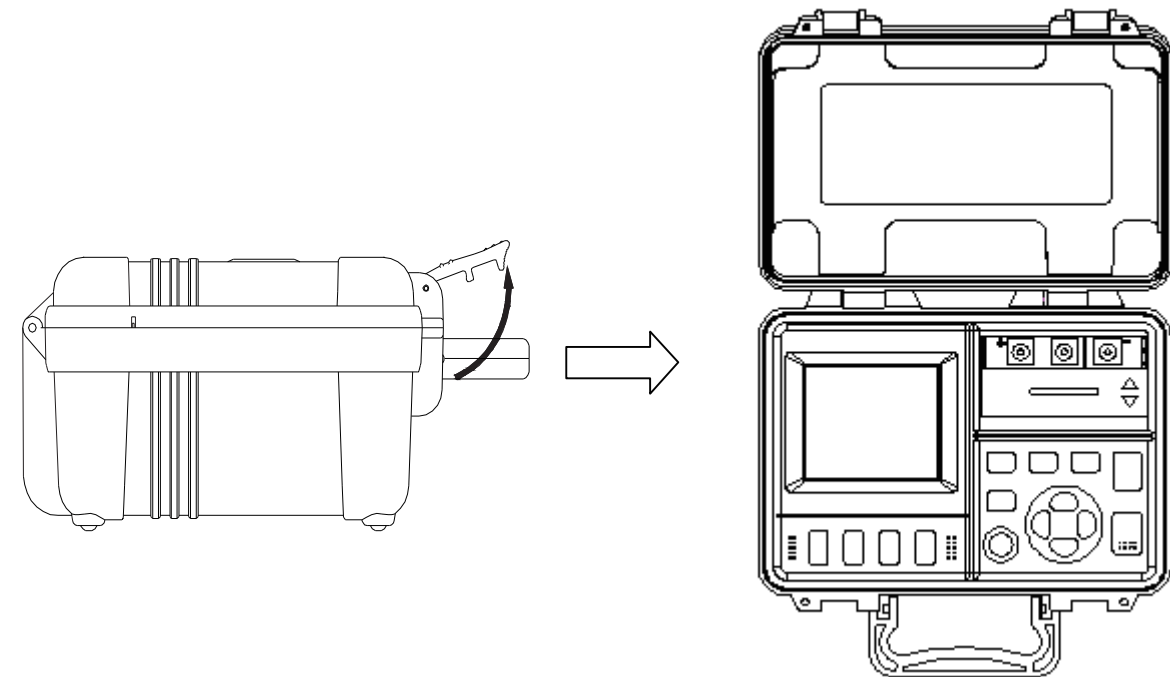

Standard Accessories



Users manual × 1

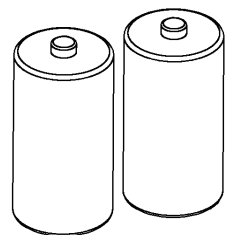

LR14 alkaline battery × 6

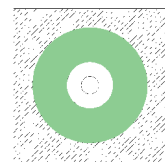

Data analysis Software × 1



Temp. sensor × 1

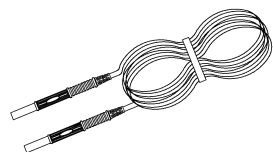

Tester probes (about 3 m)
(red, black, blue) 1 for each



USB cable × 1

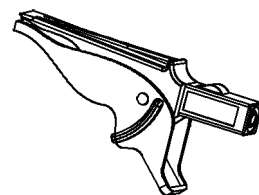

Crocodile clip (red, black, blue)
1 for each

Safety Instructions

⚠ Danger

The High-Voltage Insulation Tester has been designed according to the safety standards of EN61010-1, EN61010-2-030, CAT III 1000V, CAT IV 600V and pollution 2. Please read this manual carefully before use. If the equipment is used in a manner not specified by the manufacturer, the protection provided by the equipment may be impaired. Nevertheless, improper handling during use may still cause damages to the tester and accidents in which physical injury might occur. Our company is not liable for any accident involving physical injury that is caused by reasons other than flaws of the testing instrument itself.

Safety Symbol Descriptions

This manual contains basic points of operation safety and tester maintenance. Please read the following safety information carefully before use.

Table 1: Safety Information

	Caution, risk of danger
	Caution, risk of electric shock
	Equipment protected throughout by DOUBLE INSULATION or REINFORCED INSULATION
	Direct current
	Alternating current
	Complies with European(EU) safety standards
CAT III	MEASUREMENT CATEGORY III is applicable to test and measuring circuits connected to the distribution part of the building's low-voltage MAINS installation.
CAT IV	MEASUREMENT CATEGORY IV is applicable to test and measuring circuits connected at the source of the building's low-voltage MAINS installation.

Table 2: Definition of the Precision Symbols

This tester uses “±(% reading + digit)” to define the measurement tolerance, with the following descriptions

Digit	The smallest reading unit of the digital tester, i.e., the smallest effective number that can be shown on the digital display.
Reading or displayed value	Currently measured value and the displayed value on the tester.

Points of Attention during Operation

In order to ensure operation safety and operate with the optimal performance, please observe the following points of attention.

1. Initial checking

Before use for the first time, please check the tester for any abnormal function and make sure that no damage has occurred during storage and shipment. Please contact the supplier in case any damage is found.

Warning

Before use, please make sure that the insulation of testing probes and cables is flawless and no conducting part is exposed to the air. Otherwise, using the meter will cause electrical damage and injury. Please immediately contact the supplier for replacement.

2. Storage





Range of insulation resistance	Range of humidity within which insulation resistance test precision is guaranteed	Range of temperature within which insulation resistance test precision is guaranteed
0 Ω - 100 MΩ	<85% RH(no condensation)	23 °C ± 5 °C (73 °F ± 9 °F)
101 MΩ – 20 GΩ	<75% RH(no condensation)	
21 GΩ – 500 GΩ	<65% RH(no condensation)	
501 GΩ – 5 TΩ	<55% RH(no condensation)	

Please observe the following instructions to avoid electrical shocking and short-circuiting.

- Before connecting or disconnecting a tester probe, please make sure that the probe is detached from the object being measured and the power is turned off.
- Please do not perform any measurement when opening the battery lid.
- In case the cover of the socket is damaged, please do not use the tester.
- Please do not take off the internal components. (Because there are high-voltage devices inside)
- Please do not use the tester under environment with inflammable or explosive gas or with a lot of dust. (Otherwise explosion might occur)
- Please do not put the tester at a place where it is not stable. (In case the meter falls off, it might cause electrical malfunctions and injuries.)

Warning

High voltage will be generated by this meter during measurements, and therefore please take insulation measures according to industrial safety regulations in order to avoid electrical shock and injuries. Before use, please remind relevant persons nearby to take protective measures. In order to avoid malfunctions and accidents, please do not subject the meter to the following situations:

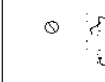
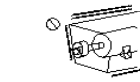
 Direct sunlight High temperature	 Corrosive explosive gas
 Spraying/splashing	 Strong electromagnetic
 Dust	 Mechanical vibration

2. Operation

Note:

- The operation range of temperatures for this meter is 0 to 40 °C (32 to 104 °F).
- During handling, transportation and operation, mechanical vibrations, especially vibrations during accident of falling off, shall be prevented, so that meter damages are avoided.
- In case the protecting function of the meter fails to work, please contact the supplier for service, or make distinct marking to prevent it being used by other persons.
- Only professional service technicians are authorized to calibrate and repair the meter.
- The meter shall not be altered in any respect, and it can only be taken apart and repaired by the service engineers of our company. Otherwise, it might cause fire, electrical shock and physical injuries.
- When the meter is not in use, please close the cover.
- Please turn off power after use.
- To avoid damaging the meter, please do not insert other devices into the USB socket or the temperature sensor terminal.

Tips:

- The standby status referred to in this manual is: the situation under which no measurement is being performed and no parameter adjustment is going on. It includes the status when HOLD symbol is displayed.
- In case ambient temperature changes abruptly in great number of degrees, it might result in condensation, which will cause incorrect measurements.
- Before starting the measurement, please first place the meter under the new test environment for a period of time.

Tips:

Common unit conversion for electrical measurements

- 1 TΩ (Tera ohm) = 1000 GΩ = 10¹²Ω
- 1 GΩ (Giga ohm) = 1000 MΩ = 10⁹Ω
- 1 MΩ (Mega ohm) = 1000 KΩ = 10⁶Ω
- 1 mA (milli ampere) = 0.001 A = 10⁻³A
- 1 μA (micro ampere) = 0.001 mA = 10⁻⁶A
- 1 nA (nano ampere) = 0.001 μA = 10⁻⁹A

1. General Description

1.1 Product Introduction

This meter is an insulation resistance tester with broad range of measurement, which can be applied for various situations from low-voltage to high-voltage measurements.

Main functions and use are as follows:

Basic Function	Insulation Resistance Test	For testing the insulation resistance of electrical equipments
	Voltage Measurement	For testing the voltage of external circuits (such as commercial power)
	Temperature Measurement	For testing the temperature
Application	Timer	For automatically stopping a test in a preset period of time
	Pi and DAR Value Display	For checking whether the leak current decreases after applying a certain voltage. It indicates that insulation of the test equipment has deteriorated when PI or DAR value is close to 1
	Temperature Compensation	For calculating the insulation resistance under various temperatures (which are different from the currently tested temperature)
Application	Step Voltage Measurement	For determining whether the insulation resistance changes with the change of testing voltage
	Save	For saving test data
	PC Communication	For transferring data that is saved in the memory to PC for table-making purpose, etc.

1.2 Features

Broad Range of Testing Voltage	1. Testing voltages with broad range can be generated (from 250 V to 5 KV). 2. Testing voltage can be preset as 250 V, 500 V, 1 KV, 2.5 KV, or 5 KV, or as a voltage increasing or decreasing in steps of 25 V or 100 V.
Insulation Diagnosis	1. PI and DAR can be automatically calculated and displayed; 2. Step-voltage measurements and temperature compensation is carried out.
Large Storage Memory	1. Up to 100 manually tested data and 10 groups of log-test data can be saved. 2. Test data can be read on LCD, or uploaded to PC
Clear Display	1. Large-screen display. Test result is displayed with indication through a graduation bar. 2. LCD screen is backlit, which is suitable for viewing when it is dark
PC Communication	1. The meter is equipped with a USB interface, through which the saved test data can be uploaded to a PC for further table/figure making and report generating with convenience.
Robust and Durable	1. With a compact structure, the tester is robust, durable and portable.
Powered by Batteries	1. With a selection switch, the tester can be powered by an alkaline battery. 2. This tester can be continuously operated for a longer period of time than similar meters if a LR14 alkaline battery is used.

1.3 General Description of Test Methods

- 1. Use: for checking the insulation of high-voltage electrical equipment
- 2. Situation: high-voltage receiving station and transformer substation
- 3. Object: electric motor, transformer, and cable, etc.

1.3.1 Test conditions

When testing the insulation resistance, please make sure that the power to the test equipment is turned off.

1.3.2 Test procedures

1.3.2.1 Preparations for the test

Before starting the measurement, please first check:

- Mode of power supply
- Status of the battery selection switch
- Settings of date and time
- Connection of the test probes.

1.3.2.2 Start testing

1.3.2.3 Insulation resistance test

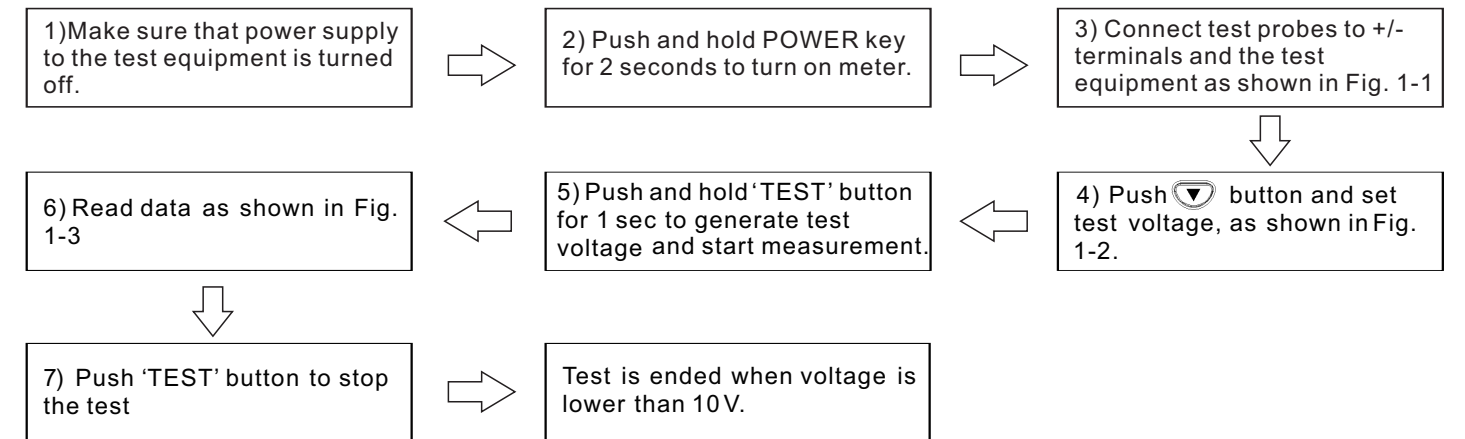

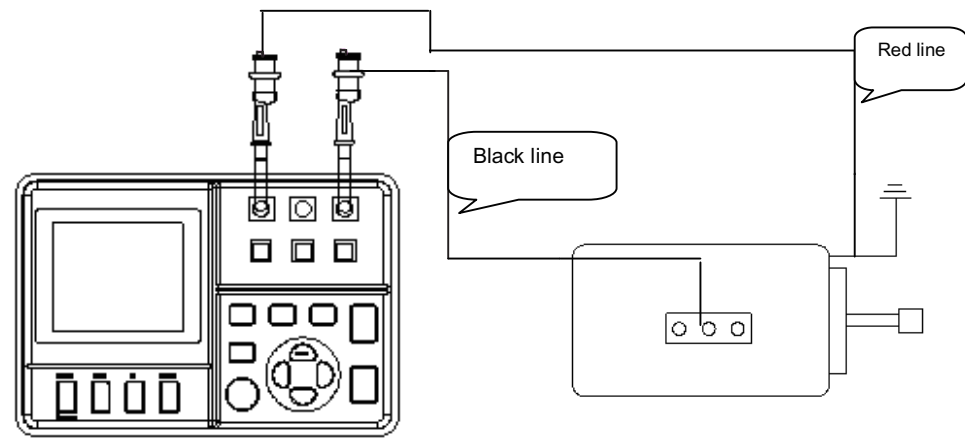

Fig. 1-1

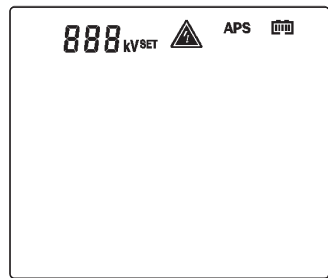

Fig. 1-2

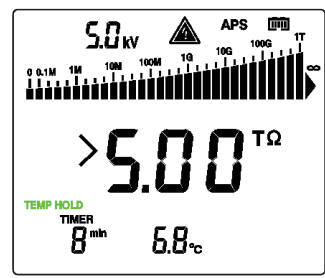

Fig. 1-3

1.3.2.3.1 Voltage test

1. Flow chart

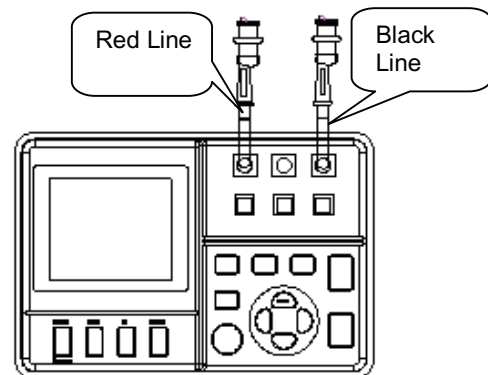
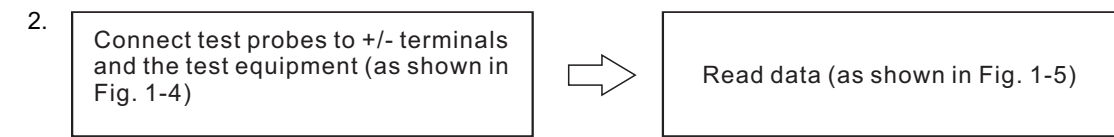

Fig. 1-4

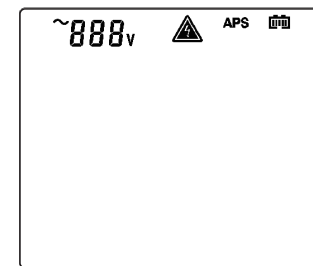

Fig. 1-5

1.3.2.3.2 Temperature test

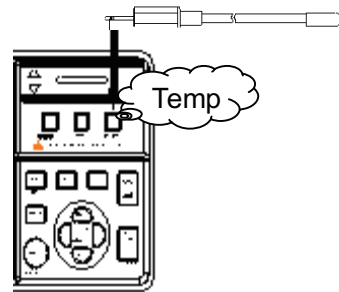
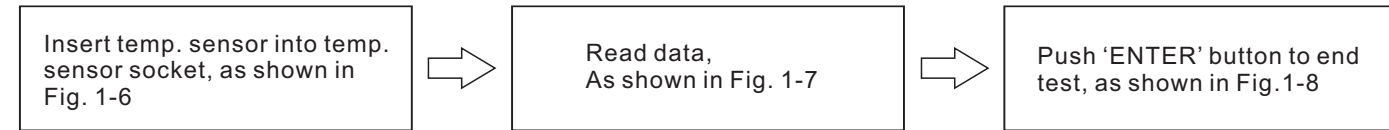

Fig. 1-6



Fig. 1-7

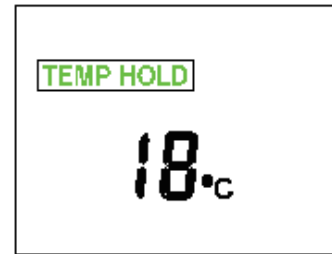
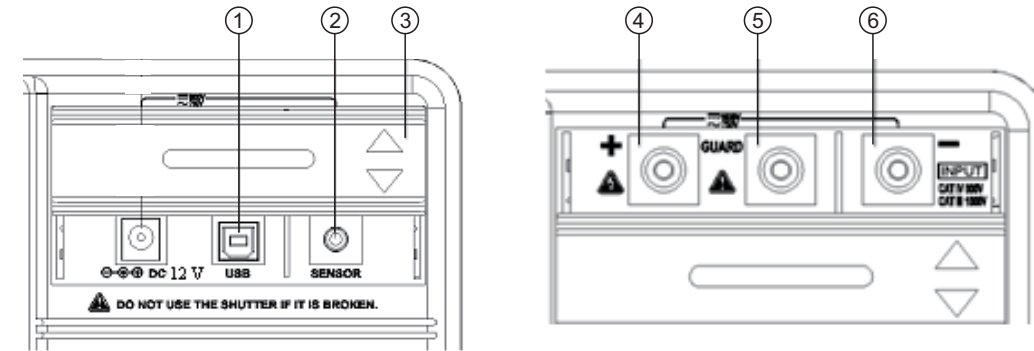

Fig. 1-8

1.3.2.3.2 Data holding

At the end of the test, the result is held, which will be cleared upon powering-off. In order to save data, please use the save function.

1.4 Names and Functions of Components



1.4.1 Front view

1.USB socket	For connecting a USB cable.
2.Temperature sensor socket	For connecting a temperature sensor
3.Socket cover	For preventing connection to another socket when connecting a test probe.
4.L(+) terminal	For connecting the red meter probe
5.GUARD terminal	For connecting the blue meter probe
6.E(-) terminal	For connecting the black meter probe

1.4.2 LCD Display-all Diagram

STEP	Step voltage
YEAR	year
SET	set
APS	Auto powering off
PI	Polarization index
DAR	Dielectric absorption ratio
HOLD	Hold the reading for insulation resistance
AVG	Displaying average value
TEMP HOLD	Holding temperature value
MONTH	Month
TIMER	Timer
DAY	Day
h	Hour
min	Minute
s	Second
USED	With data saved
TABLE NO	Temperature compensation
°C ref	Reference temperature
°C	Degree Celsius
%RH	Humidity
TC	Temperature Compensation
READ No.	Read No.
MEMO No.	Memo No.



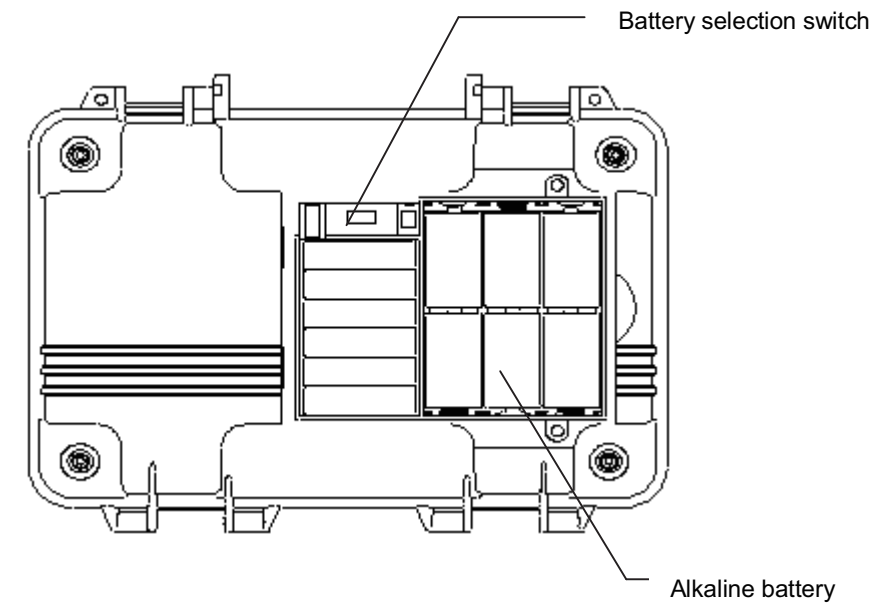

1.4.3 Back view

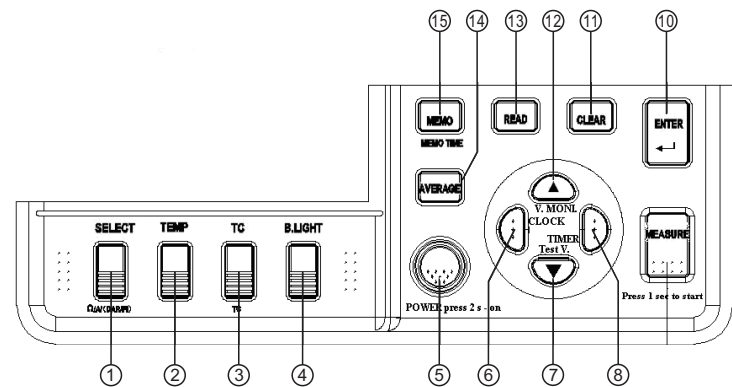

1.4.4 Operation panel



Buttons	Functions
1. SELECT	1.For changing the displayed item 2.For toggling between resistance and current display during a resistance test 3.For switching the displayed item among: resistance, current, DAR 1 min/15s, DAR 1 min/30s, PI, resistance ..., when the data of insulation resistance is held.
2. TEMP	For displaying resistor temperature, and input temperature
3. TC	For switching to the mode of temperature compensation
4. BLIGHT	For turning on/off LCD backlight, which will be automatically turned off in 30 seconds. Settings of auto power-off function.
5. POWER	For powering on/off

Buttons	Functions
6. CLOCK	1.For displaying the timer 2.For setting the timer 3.For the fine tuning of the testing voltage 4.For moving the cursor
7. 	1.For switching to the mode for setting the testing voltage 2.For selecting downwardly the value for the testing voltage
8. TIMER	1.For the fine tuning of the testing voltage 2.For moving the cursor 3.For displaying date and time 4.For setting date and time
9. Measure	1.For starting or stopping resistance test 2.It will flash after the testing voltage is generated 3.It will flash if the input voltage is greater than 50 V, or when discharging occurs.
10. ENTER	Confirm or stop a temperature test
11. CLEAR	For clearing the saved data
12. 	1.For selecting upwardly the value for the testing voltage 2.For toggling between the set voltage and the testing voltage after a resistance test is completed 3.It will flash after the testing voltage is generated 4.It will flash if the input voltage is greater than 50 V, or when discharging occurs
13. READ	For reading the data
14. AVER	For decreasing abrupt changes of resistance/current
15. MEMO	For saving data; For displaying saved data

2. Preparations before the Test

2.1 Power Supply

Power Supply: 6 X 1.5V LR14 alkaline batteries

2.1.1 Battery Installation/Replacement

Warning

1. In order to avoid damaging the battery, please turn off power and take off the meter probes before replacing batteries.
2. Please do not use an old battery in combination with a new one, and do not use batteries of different models.
3. Please pay attention to the polarity of the batteries during installation, otherwise it might decrease battery performance or even damage the battery.
4. Please do not short-circuit or take apart used batteries in order to avoid explosion or environmental pollution.
5. Please properly dispose used batteries according to the requirements of local laws and regulations.
6. The battery should be replaced if there is an indication that the battery is short of power.
7. Only designated batteries may be used.
8. Please do not use manganese batteries, otherwise it will greatly shorten the time period for continuous operation.
9. In order to avoid corrosion caused by battery leakage, please take out batteries when the meter is not to be used for a long period of time.

2.1.1.1 Operation Procedures

1. Turn off power, and take off all the test probes.
2. Loose the screws on the back, and take off the battery cover.
3. Place 6 X LR14 alkaline batteries in the battery case.
4. Switch the battery selection switch to alkaline battery.
5. Put back the battery cover and tighten the screws.

2.2 Powering on/off

2.2.1 Powering on

1. Press and hold "POWER" button for more than 2 seconds, and the screen display will be turned on and the tester will be under standby mode; Upon powering-on, the parameters which were set before powering-off last time will be automatically loaded.
2. If the battery power is at a low level, please replace the battery; If you continue using the meter after 'LobAt' is displayed, the meter will be automatically turned off.

2.2.2 Powering off

Press and hold "POWER" button, and the screen display will be turned off and the power switched off.

2.2.3 Auto powering off

1. The tester will be automatically turned off if it is not in use for 10 minutes. The auto powering-off function will be invalid during insulation resistance measurement and temperature measurement.
2. Before auto powering off, APS symbol will flash for 30 seconds.
3. Auto powering-off function can be set when the meter is powered on.
4. Auto powering-off function will be invalid when the charger is used.

2.2.3.1 Cancelling auto powering-off

Press and hold "B. LIGHT" button during powering-on to cancel auto powering-off function.

2.3 Setting and checking date / time

Before use, date and time should be set.

2.3.1 Setting date and time

2.3.1.1 Operation procedures

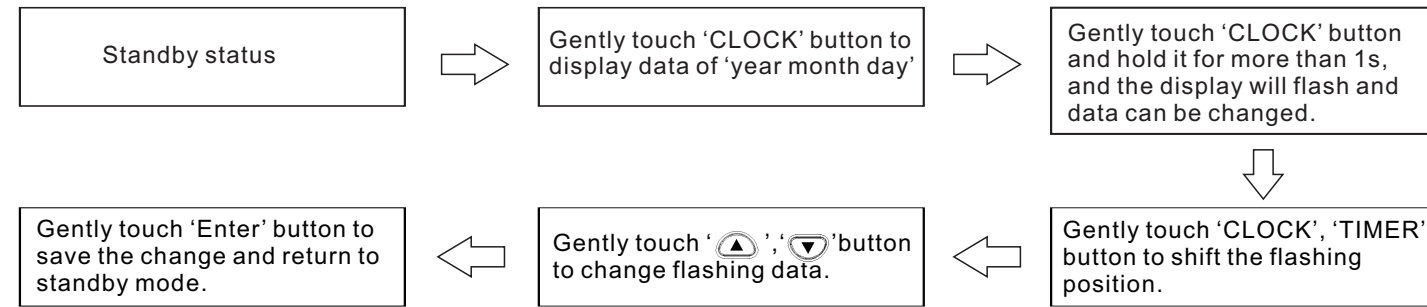

Note 1: Upon pressing the confirmation button, the clock starts to run from zero second.
 Note 2: Date and time can be set through the communication software that is installed on a PC.

2.3.2 Checking date and time

2.3.2.1 Operation procedures

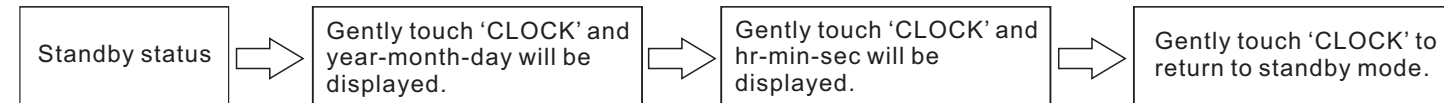

2.4 Connecting meter probes

2.4.1 Operation procedures

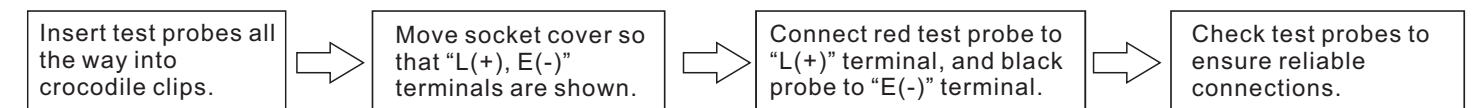

⚠ Danger

1. Before connecting or disconnecting a tester probe, please make sure that the probe is detached from the object being measured and the power is turned off in order to avoid electrical damages.
2. In order to avoid electrical damages, please do not use the tester when the housing is damaged.

⚠ Note

The meter probes cannot be connected when the charger, temperature sensor, or USB cable is used.

2.5 Connecting the temperature sensor

⚠ Note

1. High-voltage or static charge can damage the temperature sensor. Strong collision or a bent cable might cause malfunctions.
2. The temperature sensor cannot be used together with the meter probes.

2.5.1 Operation procedures

1. Move the socket cover, and you will see the temperature sensor socket.
2. Insert the plug of the temperature sensor into the socket, and temperature measurement will automatically begin.

3. Test Methods

3.1 Checking before the Test

In order to ensure safety, please check carefully before use.

⚠ Warning

1. Before use, please make sure that the insulation of the testing probes and cables are flawless and no conducting part is exposed without insulation; otherwise, using the meter will cause electrical damage and injury. Please contact the supplier for replacement.
2. Please make sure that the socket is clean and dry. Use a piece of dry cloth to wipe off any water to avoid test error.
3. Check the bottom shell of the tester, top cover, testing probes and alligator clips for damages; please do not use the meter in case any damage is found.
4. Check readings for testing voltage and resistance.
5. Prepare a calibration resistor (voltage-proof value: 5 kV, resistance: 20 MΩ); also prepare a DC voltage meter (input resistance: greater than 1,000 MΩ, measuring range for voltage: greater than 5.5 kV DC).

3.1.1 Checking procedures

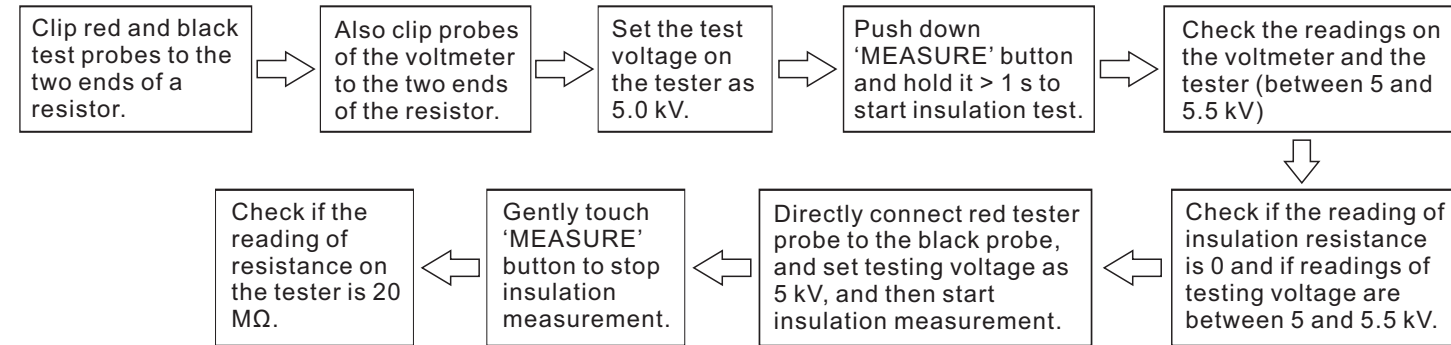

Note: In case any problem is found, please do not use the tester.

3.2 Insulation resistance test

⚠ Danger

Please observe the following instructions during use to avoid electrical damage and short-circuiting.

1. In case the socket is damaged, please do not use the tester.
2. Perform checking according to Table 3-1 before connecting test probes.
3. Before measurement, please make sure that the test object is not live.

Table 3-1

Items for check	Results of check	Measures to be taken
If the flash mark and the backlight of 'measure' button are turned off?	Turned off	Connect test probes to the tester and check the three points as listed above this table; If everything is safe, connect the probes to the test object. Perform checking according to Table 3-2.
	Flashing	Press 'measure' button to stop generating voltages.

Table 3-2

Items for check	Results of check	Measures to be taken
If the flash mark and the backlight of 'measure' button are flashing?	Not flashing	Measurements can be carried out.
	Flashing	Immediately disconnect the test probes from the test object. Turn off the power supply for the test object, or discharge the test object.

⚠ Warning

1. Dangerous voltages might be generated at the test terminals during insulation resistance measurements, and therefore please do not touch the terminals or test probes in order to avoid electric shock.
2. Please do not touch the object that is being tested or disconnect the test probes before auto discharging is completed, otherwise electric shock might occur.
3. Even if power on/off button is never pressed, the battery power of the tester might still be exhausted due to other reasons, such as battery leakage; under this situation, auto-discharging function might be invalid, and therefore please use a discharging rod to discharge the test object.

⚠ Note

1. In order to avoid damaging the equipment that is to be tested, please check the test voltage before measurement.
2. For repeating a test, please press '⏏' button prior to the next measurement and check the test voltage.
3. In order to avoid damaging the tester during discharging, do not measure the insulation resistance between the two terminals of a capacitor (greater than 4 μF).
4. In order to avoid damaging the tester, please do not directly connect the red tester probe to the blue probe.

3.2.1 Start testing

3.2.1.1 Operation procedures

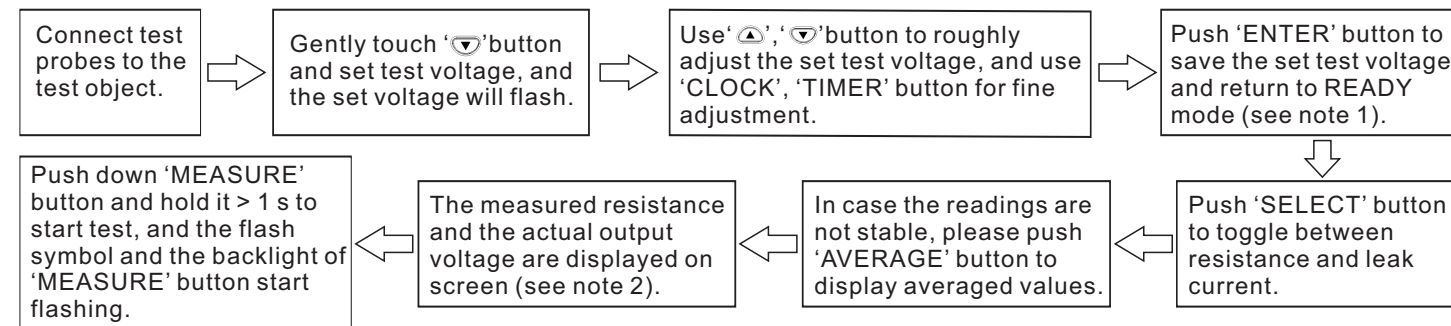

⚠ Tips

Note 1: When flashing readings change to a constant one, it indicates that test voltage is successfully set.

Note 2:

- 1) If '>' symbol starts to flash, it indicates that the measured value is too large and exceeds the measuring range.
- 2) During the measurement, 'SET' symbol will not be displayed, and voltage indication will change from readings of test voltage to readings of actual output voltages which are about 5% higher than the set voltage.
- 3) In order to check the test voltage during the measurement, please press '⏏' button, and value of the set voltage will be displayed for about 2 seconds.
- 4) If the output voltage is lower than the set voltage during the measurement, the voltage readings will start to flash.
- 5) The elapsed time since the start of the measurement is displayed under the resistance readings; if the timer is set, the remaining time will be displayed at the same position.
- 6) If the readings are not stable, you can use the measurement average function as follows: press 'AVERAGE' button to activate/deactivate AVERAGE function; after 'AVE' symbol is displayed, the readings will be updated every 4 seconds; however, the readings will still be updated every 1 second under the following situations: within the first 15 seconds after the start of measurement; within the first 5-10 seconds after the measuring range is changed.

⚠ Note

1. Do not let the tester probes come into contact with each other, and do not place other objects on the probes so that measuring errors can be avoided.
2. Before use, please make sure that the tester probes are clean; a smeared probe will adversely affect the measurement: insulation resistance will not be stable, and for certain objects, measured values will not be consistent.
3. The capacitance and resistance of the object being tested might be low initially, and then increase gradually, and finally be stabilized.
4. If resistance of the object being tested decreases abruptly or the test probes are short-circuited during the measurement, the tester might stop generating test voltage.
5. Insulation resistance measurement cannot be started under the following circumstances:
 - 1) When the set value of test voltage is flashing, which indicates that the tester is under the setup mode;
 - 2) When 'HOLD' symbol is flashing;
 - 3) When 'TC' symbol is displayed, and the reading for actual measured temperature is ---;
 - 4) When an error message is displayed.

3.2.2 Finishing a test

3.2.2.1 Operation procedures

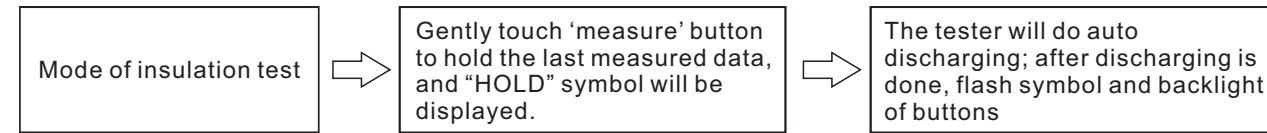

⚠ Note

1. Before stopping measuring, do not disconnect the tester probes from the object being tested.
2. Once the measurement is finished, the discharging circuit will automatically start to discharge the object being tested; The flash symbol and backlight of 'measure' button will keep flashing during discharging; You can check the discharging process with the voltage readings.
3. When voltage drops below 10 V, discharging will stop and the flash symbol and backlight of 'measure' button will be turned off.
4. If Power on/off button is pushed during measuring, it will automatically carry out discharging before powering off.
5. In case battery power is insufficient during measurement, the tester will automatically stop the measurement and start the auto discharging process, and LObAt symbol will be displayed.

3.2.3 Review and delete the held data

3.2.3.1 Review the held data

After the insulation resistance measurement is finished, the following values will be displayed on screen.

1. Insulation resistance (with the value and a graduation bar)
2. Testing voltage
3. Actual output voltage
4. Leak current
5. Time spent for the measurement

Press the buttons shown in the following table to switch the display for other measured data

3.2.3.1.1 'SELECT' Button



3.2.3.1.2 '▲' Button



3.2.3.1.3 'TEMP' button

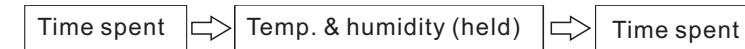

⚠ Note

Held data will be cleared after powering-off, and therefore please use SAVE function to save data.

3.2.3.2 Delete the held data

Push 'CLEAR' button and hold it for longer than 1 second to clear the held data. Data of temperature and humidity will not be cleared

3.2.4 Auto-discharging function

⚠ Note

1. When testing a component with capacitor characteristics, the test component will retain a high voltage, which is very dangerous. After the measurement is finished, the tester will carry out auto-discharging through the internal circuit; before pushing 'measure' button to stop the test, please make sure that the tester probes are still connected to the object being tested.
2. When voltage is below 10 V, auto-discharging will stop, the duration of which depends on the value of capacitance.

⚠ Warning

After voltage is decreased through auto-discharging, voltage at the measuring points might increase again; therefore, please be very careful when touching the test object.

3.2.5 Reviewing other test data

3.2.5.1 When 'HOLD' symbol is not displayed before a resistance test or after setting a test voltage, with every push on 'SELECT' button, the displayed value will switch in the following order:

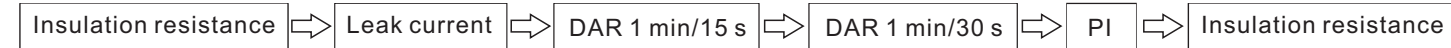

3.2.5.2 With every push on 'SELECT' button during a measurement, the displayed value will switch in the following order

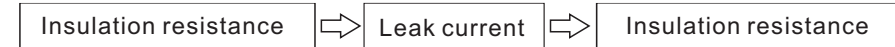

3.2.5.3 With every push on 'SELECT' button when results are held after the test, the displayed value will switch in the following order

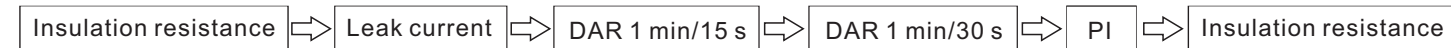

3.2.6 Principle of insulation resistance test

1. Leak current (I) will be generated when a high DC voltage (V) is applied on the test object. The insulation resistance tester measures applied voltage and the generated current, and calculate the insulation resistance.
2. When repeating measurements on the same test object, it is possible that each measurement results in a different insulation resistance value and leak current value. This is caused by polarization effect which occurs when applying voltage on the insulation material. Insulation material can be represented by an equivalent circuit, as shown in the diagram below: IA stands for the absorbing current generated by slow polarization; it takes some time for the polarization resulted from last test to disappear. There is still charge remaining in CA until the polarization disappears; the charge in CA during last test is different from that at the beginning of the test that follows, and therefore the absorbing current (IA) is different, too. Therefore, every test gives different combined leak current and insulation resistance; In order to ensure reproducible measurements, please leave sufficient time between every two tests, and additionally, keep ambient temperature and humidity relatively stable.

Calculation equation: $R = V/I$

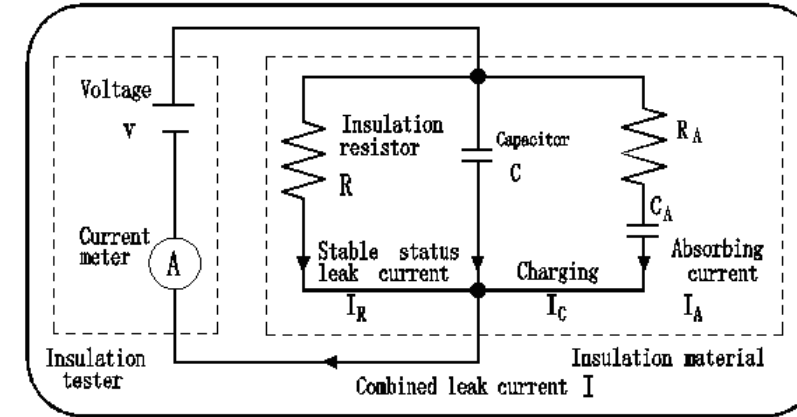

After the voltage is applied, I_C and I_A decrease gradually.

3.2.7 Using GUARD terminal

3.2.7.1 Diagram for using GUARD terminals in cable tests

GUARD terminals are used in order to prevent the surface resistance of insulation materials from affecting the measurement so that all materials can be measured correctly; a diagram for cable measurement is shown below:

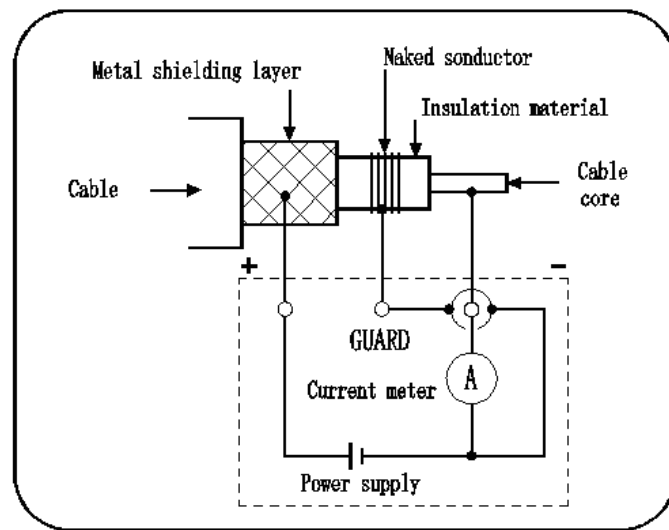

Rc: insulation resistance of the insulation material for high-voltage cables (between core and metal shielding layer)
 Rs: insulation resistance of the protective layer for high-voltage cables (between metal shielding layer and earth)
 Rn: insulation resistance between the insulation device or high-voltage equipment and earth. Interference from Rs and Rn is eliminated, and only Rc is tested.

⚠ Danger

When GUARD terminals are mistakenly connected to external power source or there is a problem during a GUARD test, the meter will intermittently give off alarming and Err will be displayed on screen; at this time, you shall immediately stop test and solving the problem.

3.3 Reviewing other test data

This tester can be used for measuring voltages in external circuits. The tester can automatically differentiate between AC and DC.

⚠ Danger

In order to avoid damages to the equipment or physical injuries, please observe the following:

1. Max. rated voltage (relative to earth): 1,000 Vrms (CATIII), or 600 Vrms (CATIV)
2. Max. input voltage: AC 750 V RMS, or DC 1000 V
3. Max. input frequency: 70 Hz
4. Do not make short-circuiting with a crocodile clip.
5. In case the cover of the socket is damaged, please do not use the tester.

3.3.1 Operation procedures for voltage measurements

1. Fully insert the tip of the tester probes into the crocodile clips.
2. Move and open the socket cover, and you will see "L(+), E(-)" terminals.
3. Insert the red tester probe into "L(+)" terminal, and black probe into "E(-)" terminal.
4. Connect the crocodile clips, which have already been connected to the tester probes, to the two ends of the test object; when voltage is greater than 50 V, the flash symbol and the backlight of 'measure' button will flash.
5. Without pushing the 'measure' button, you can directly read the displayed voltage value.

3.4 Temperature test

3.4.1 Operation procedures for temperature tests

1. Move the socket cover upward, and you will see the temperature sensor socket.
2. Insert the temperature sensor into the temperature sensor socket. Temperature measurement will automatically start.
3. Read the temperature value.
4. Push 'ENTER' button or take off the temperature sensor to stop temperature measurement, and TEMP HOLD symbol will be lit up and the last measured temperature value will be displayed and held.
5. OF indicates that temperature is over 70 °C; -OF indicates that temperature is lower than -10°C.

⚠ Tips

- Note 1: If temperature measurement is stopped by pushing 'ENTER' button, it can be resumed by pushing 'TEMP' button.
- Note 2: When an insulation resistance value is held and if the temperature sensor is not connected, display of temperature will be switched to display of the time spent for measuring the insulation resistance; in order to display the held temperature value, please push TEMP button for switching (temperature value will flash).
- Note 3: The held data will be cleared after powering-off, and therefore please use the SAVE function to save data.
- Note 4: Parameters cannot be set during a temperature measurement.

⚠ Warning

Do not measure the temperature of a live object; otherwise, it might result in short-circuiting, malfunctions, or electric shock.

⚠ Note

High-voltage or static charge can damage the temp. sensor. Do not bend the sensor cable.

4. Advanced test functions

4.1 Use of the timer

Application:

1. It can be used to automatically stop the test after a preset period of time.
2. With the timer function, time can be set between 30 seconds and 30 minutes (When the set time is greater than 1 minute, it can be adjusted in steps of 1 minute).

4.1.1 Setting the timer / controlling insulation resistance test

4.1.1.1 Operation procedures for using the timer

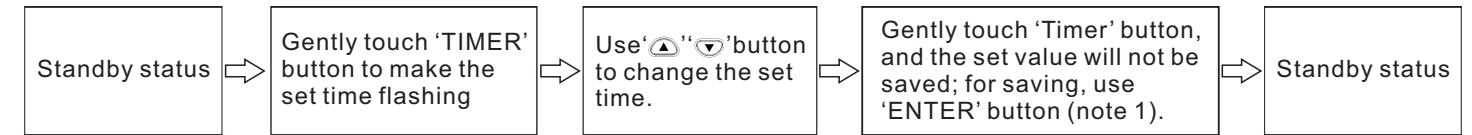

⚠ Tips

- Note 1: After the timer is successfully set, 'TIMER' symbol will be lit up.
- Note 2: After the timer is successfully set and when it is in an insulation test, the remaining test time is displayed at the bottom of the screen.
- Note 3: The measurement will automatically stop upon reaching the set time.
- Note 4: If 'measure' button is pushed, the measurement will be immediately stopped no matter how many minutes are remaining, and the time spent for measuring will be displayed at the bottom of the screen.
- Note 5: When APS function is turned on, the auto powering-off function is activated, and the tester will be automatically turned off about 10 minutes after the end of the test.

⚠ Warning

Do not measure the temperature of a live object; otherwise, it might result in short-circuiting, malfunctions, or electric shock.

⚠ Note

High-voltage or static charge can damage the temp. sensor. Do not bend the sensor cable.

4.1.2 Turning off the timer

Operation procedures



⚠ Tips

Note 1: After the timer is cancelled, the TIMER symbol will be turned off.

4.1.3 Checking the preset timer

Operation procedures

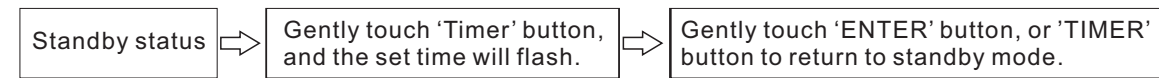

4.2 Displaying PI and DAR

4.2.1 Application of PI, DAR

- For objects being tested which with large capacity and long absorption process, such as electrical devices including transformer, generator, cable, and capacitor, sometimes the absorption ratio R_{60S}/R_{15S} is not sufficient to give you information of the whole process of absorption; therefore, we can use a ratio of insulation resistance for a long period of time, i.e., use PI, the ratio of insulation resistance at 10 min ($R_{10\text{ min}}$) over that at 1 min ($R_{1\text{ min}}$), to describe the whole process of insulation absorption, where PI is called insulation polarization index; In engineering, the insulation resistance and the absorption ratio (or polarization index) can give you information about the degree to which the insulation devices of generator and oil-dip power transformer are subject to dampness. After insulation parts are subject to dampness, the absorption ratio (or polarization index) decreases (as shown in Fig. 1), and therefore it is an important index for telling out whether an insulation part is subject to dampness.

It should be pointed out that sometimes an insulation part with obvious drawbacks (e.g., the insulation part is broken through under high voltage) is nevertheless with a good absorption ratio (or polarization index). Therefore, absorption ratio (polarization index) cannot be used to discover local insulation drawbacks other than dampness and contamination.

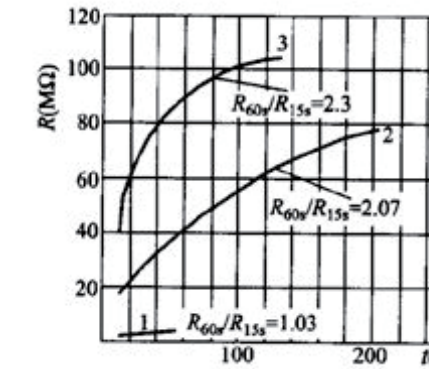

1- Before drying, 15 °C; 2 - after drying, 73.5 °C; 3 - after running for 72h, and being cooled to 27 °C

Fig. 1 Dependence of insulation resistance R on time t for a power generator

- PI and DAR values can be automatically calculated as a reference for evaluating the insulation performance, because both parameters show the change of insulation resistance after the test object is subject to a testing voltage for a certain period of time.
- PI and DAR values can be calculated with the following equations:

$$PI(\text{polarization index}) = \frac{R_{10\text{ Min}}}{R_{1\text{ Min}}} \quad / \quad DAR(\text{absorbing ratio}) = \frac{R_{60\text{ Sec}}}{R_{15\text{ Sec}}} \quad / \quad DAR(\text{absorbing ratio}) = \frac{R_{60\text{ Sec}}}{R_{30\text{ Sec}}}$$

⚠ Tips

1. R 10 Min = Resistance value measured 10 minutes after applying the test voltage
2. R 1 Min = R 60 Sec = Resistance value measured 1 minute after applying the test voltage
3. R 30 Sec = Resistance value measured 30 seconds after applying the test voltage
4. R 15 Sec = Resistance value measured 15 seconds after applying the test voltage

4.2.2 Operation procedures

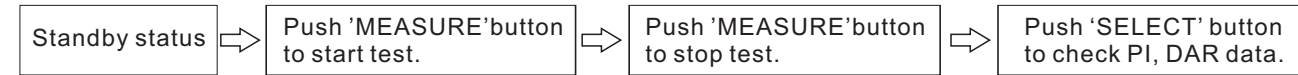

⚠ Tips

- Note 1: In order to display DAR value, AVERAGE function must be turned off before measuring.
- Note 2: In order to display PI value, the time spent for measuring insulation resistance must be longer than 10 minutes (under the default situation).
- Note 3: In order to display DAR value, the measuring time must be longer than 1 minute.
- Note 4: When pushing 'SELECT' button to review data, the displayed data will switch in the following order:

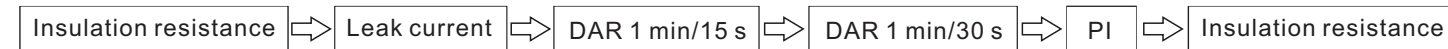

- Note 5: If the measurement is stopped before the set time expires, the screen will display '---'.
- Note 6: If TC function is turned on, then PI and DAR values cannot be displayed.
- Note 7: PI and DAR values also cannot be displayed under the mode of step-voltage measurement.
- Note 8: If the value of insulation resistance flashes, the displayed value might be incorrect (because resistance changes rapidly before the preset time is reached, so that the internal circuit cannot respond to it; The measuring range needs to be changed); If the value of resistance flashes, then PI and DAR values can only be used as a rough reference; Please carry out measurement again.
- Note 9: The following table describes the meaning of special displaying for PI and DAR.

Displayed PI, DAR values	Description
---	One or more values of resistance are not successfully measured. One or more values of resistance exceed the measuring range. The first measured value is 0.
>999	PI or DAR value is greater than 999.
<0.01	PI or DAR value is less than 0.01.

4.3 Temperature Compensation

4.3.1 Application

1. It can be used for obtaining the insulation resistance under a temperature other than current ambient temperature.
2. The tester converts the measured value of resistance to the insulation resistance under a reference temperature, and displays the result.
3. Depending on the different properties of test objects, there are 10 modes of compensation (for details, see attached table 1).
4. The reference temperature can be set as any temperature in the range of reference temperature which depends on the mode of compensation, and the range of test temperature for conversion also depends on the mode of compensation (see attached table 1).

4.3.2 Applying temperature compensation

Operation procedures:

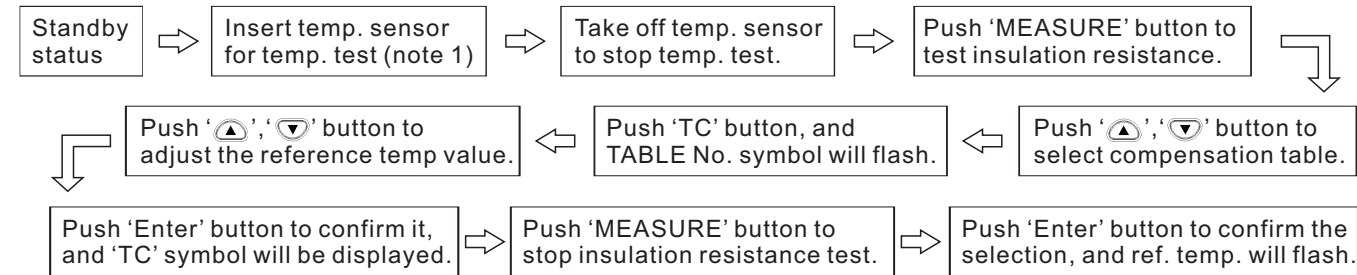

⚠ Tips

- Note 1: Temperature values can be entered through the keyboard; for TC test, the temp. range is 0-40 °C; when this range is exceeded, you can press 'ENTER' button to display 'Err' and alarming indication, and then you can input a correct temperature value.
- Note 2: Temperature compensation is invalid under the mode of step-voltage measurement (under which STEP symbol is displayed).
- Note 3: If TC symbol is lit up, it signifies that the tester is under the mode of temperature compensation, and the screen will display insulation resistance under the reference temperature converted from the measured value. The graduation bar still shows the resistance value before conversion.
- Note 4: If the resistance value before conversion already exceeds the measuring range, temperature compensation cannot be performed and the screen will display '---'.
- Note 5: If the temperature value is not held (TEMP HOLD symbol is not displayed) under the mode of temperature compensation, please measure or enter the temperature value before measuring resistance; Do not measure resistance before holding a temperature value.
- Note 6: Push 'SELECT' button under the mode of temperature compensation to switch the display to value of leak current, however, the displayed leak current will be the value without compensation.

The buttons for switching the display is listed in the following table.

Displayed values for switching	Button used
Insulation resistance after compensation ↔ leak current without compensation	SELECT
Temperature / reference temperature ↔ time spent	SELECT
Actual temperature setup ↔ idle mode	TMP

4.3.3 Application

Procedures:

Push TC button, and TC symbol will be turned off and the mode of temperature compensation will be cancelled.

4.4 Step-Voltage Measurement

1. Application: it is used for observe the effect of testing voltage on the insulation resistance of the test object.
2. What is step-voltage measurement?
The tester increases the testing voltage step by step, and tests insulation resistance and leak current; If the insulation resistance decreases with the increase of the testing voltage, it indicates that the insulation material of the test object has been damaged or polluted and attention should be given in this regard (Standard for reference: IEEE43-2000).
3. General description of the test
 - 1) The testing voltage is increased in five steps at equal intervals during the insulation resistance measurement, and the values of insulation resistance and leak current are obtained at the end of each step;
 - 2) The testing voltages are applied in one of the following two sequences:
STEP (2.50 kV): 500 V, 1 kV, 1.5 kV, 2 kV, and 2.5 kV
STEP (5.00 kV): 1 kV, 2 kV, 3 kV, 4 kV, and 5 kV
 - 3) The voltage is increased after the time for generating voltage in each step is exceeded; the measurement is automatically stopped after the meter carries out the 5 step test;
 - 4) The value of generated voltage increases step by step; however, the time interval for every step is the same.

4.4.1 Setting and managing step-voltage test

Operation procedures:

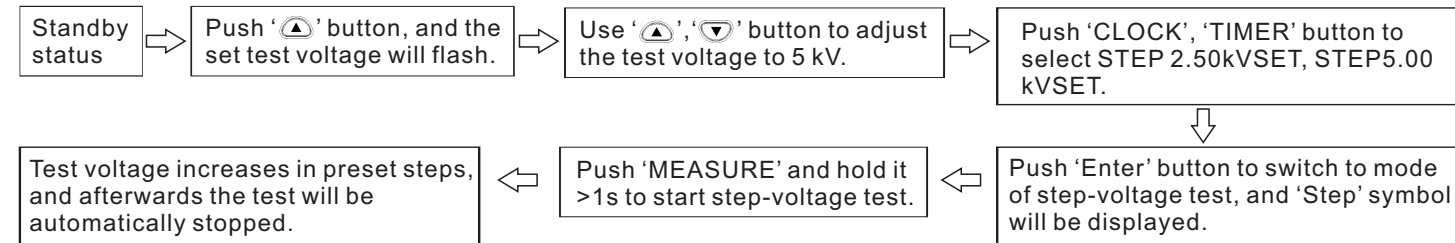

⚠ Tips

Note 1: Data of the last step is held and displayed (HOLD symbol is lit up).

Note 2: When TC symbol is displayed (under the temp. compensation mode), the tester cannot conduct test under the mode of step-voltage measurement.

Note 3: If you need to check the set voltage during measurement, just push ▲ button, and the set voltage will be displayed for about 2 seconds; At the end of measurement, push ▲ button to switch between the last input voltage and the last measured voltage.

4.4.2 Reviewing test data at every step

Operation procedures:

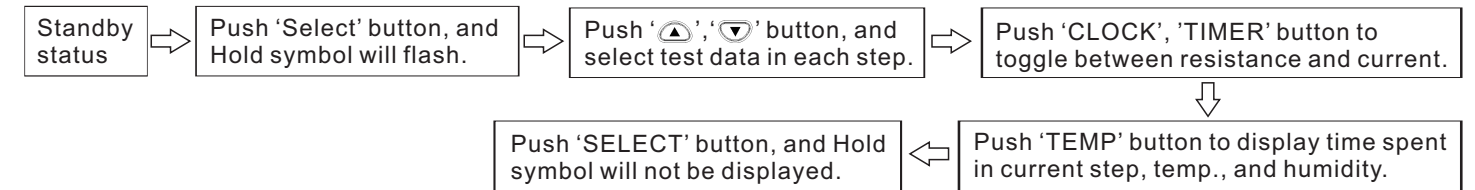

4.4.3 Exiting the mode of step-voltage measurement

Operation procedures:



5. Saving test data (save function)

1. The tester can save test data, set parameters, time and date in the internal memory, and the saved data will not be lost after powering-off.

There are two modes of saving:

1) Manual saving: The held data is saved; the saved data can be reviewed on the screen, or be uploaded to a PC through a USB port.

2) log recording: Insulation resistance is saved at specified intervals; Only data of the last record can be reviewed on the screen, while all data can be reviewed on PC with the PC software.

The data record number of the log record works as memory address in the memory.

2. The data record number is listed in the following table.

Mode of Recording	Mode of Recording
Manual recording	00-09, 10-19, 20-29, 30-39, 40-49, 50-59, 60-69, 70-79, 80-89, 90-99 (Total 100 data)
Log recording	Lr0-Lr9 (Total 10 groups of data, with each group containing up to 360 values)

The following table lists types of data that can be saved.

Mode of Recording	Type of data	Data saved in each record
Manual recording	Standard test data	Data number, year/month/day/hour/minute/second, time spent, set test voltage, actual output voltage, last measured resistance value /measured resistance value after 15 seconds / measured resistance value after 30 seconds / measured resistance value after 1 minute, user-defined PI time interval, resistance value at user-defined time interval

Mode of Recording	Type of data	Data saved in each record
Manual recording	Temperature compensation data	Data number, year/month/day/hour/minute/second, time spent, temperature, humidity, set test voltage, actual output voltage, resistance value, reference temperature/humidity value, resistance value after compensation, compensation table number
Manual recording	Data from step-voltage measurement	Data number, year/month/day/hour/minute/second, step time, temperature/humidity, set test voltage, five groups of actual output voltages, five groups of insulation resistance values
Log recording	-----	Year/month/day/hour/minute/second, measurement time interval, temperature/humidity, set test voltage, 360 groups of actual output voltages, 360 groups of insulation resistance values

Note 1: Only the last measured value in each step is recorded under mode of step-voltage measurement.

Note 2: The result of voltage measurement cannot be saved.

5.1 Saving test data

5.1.1 Manual recording

1. Altogether 100 manually saved data can be saved in 10 groups (10 records for each group).
00-09, 10-19, 20-29, 30-39, 40-49, 50-59, 60-69, 70-79, 80-89, 90-99
2. Altogether there are three types of data:
 - 1) Standard test data;
 - 2) Temperature compensation data;
 - 3) Data from step-voltage measurement.
 The saving modes for these three types of data are different.
3. Operation Procedures

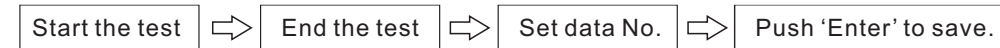

4. Operation procedures

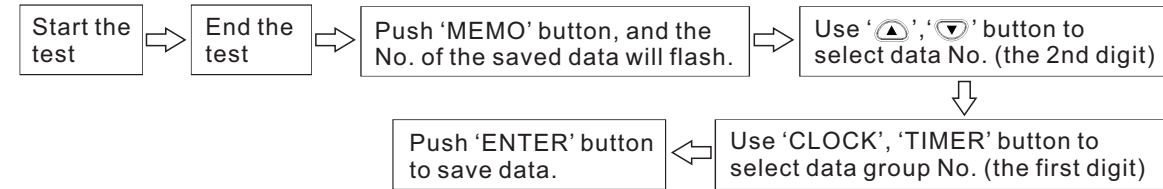

⚠ Tips

- Note 1: A single temperature value or values of temperature /humidity can be saved as manual data. The tester must be under the mode of standard measurement (STEP and TC symbols are not displayed). A single temperature/humidity value cannot be saved under the mode of step-voltage measurement and the mode of temperature compensation.
- Note 2: If USED symbol is displayed for the selected data number, the saved data will be overwritten.
- Note 3: If MEMO button is pushed instead of ENTER button, data will not be saved.
- Note 4: If applying of step voltage is stopped in the middle of the measurement, data cannot be saved.
- Note 5: If power is turned off when MEMO No. symbol is flashing, data will be lost.

5.1.2 Log recording

1. The tester saves values of insulation resistance at the specified intervals, and altogether 10 groups of data can be saved (Lr0 - Lr9) with each group containing up to 360 values. The time interval can be chosen from: 15 seconds, 30 seconds, 1 minute, 2 minutes, and 5 minutes.
2. The number of data that can be recorded in each group and the time period of the record depend on the set time interval (with timer turned off).

Time interval of recording	Max. number of recorded data	Max. recording time
15 seconds	360	90 minutes
30 seconds	360	3 hours
1 minute	360	6 hours
2 minutes	250	8 hours and 20 minutes
5 minutes	100	8 hours and 20 minutes

3. If the timer is set and when the set time expires, the measurement will automatically stop; the time can be chosen from: 30 seconds – 30 minutes.
4. The period of time for continuous recording is affected by battery power; If the battery power becomes insufficient during the measurement, LobAt symbol will be displayed and data recording will stop.
5. If the tester is measuring a very low value of insulation resistance and consumes a lot of battery power, then the maximum number of data that can be recorded by the tester might decrease.

Operation procedures



⚠ Tips

- Note 1: Please push 'MEMO' button to exit the setup mode without changing internal settings.
- Note 2: Please push 'MEMO' button to exit log-recording mode.

5.1.2.1 Manual recording

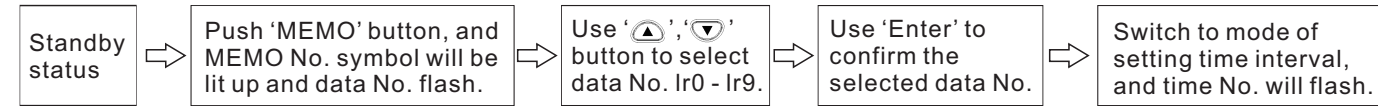

⚠ Tips

- Note 1: If the held data is displayed, the log-recording mode cannot be accessed, and therefore you need to push CLEAR button to clear the held data before proceeding to the next step.
- Note 2: The mode of log-recording cannot be accessed under the mode of step-voltage measurement or the mode of temperature compensation.
- Note 3: When a value of temperature or humidity is held and if you push 'SAVE' button, it will switch to the interface for saving standard data.
- Note 4: If USED symbol is displayed for a certain data number, it indicates that there is already data saved under this number; because data cannot be overwritten under log-recording mode, you need to delete the saved data before saving new data.
- Note 5: When there are 10 groups of data saved in the log record and if 'SAVE' button is pressed, FUL will be displayed and alarming indicator will appear. If you wish to save more data, you need to delete the previous data and then press "SAVE" button to access the log record mode.

5.1.2.2 Procedures for setting recording intervals

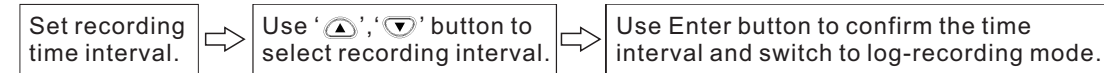

5.1.2.3 Procedures for setting the timer

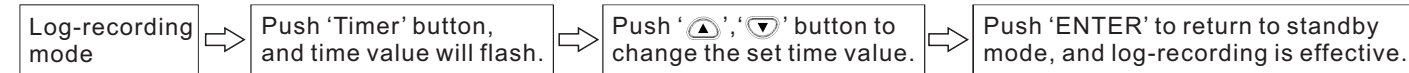

5.1.2.4 Testing

1. Start the insulation resistance measurement, and the first data will be obtained after the first specified time interval.
2. Insulation resistance measurement will stop under the following three circumstances:
 - If time reaches the Max. recording time; or
 - If time reaches the set period of time in the timer; or
 - If 'measure' button is pushed.
 Data number starts flashing at the end of measurement, while data has not been saved at this moment.
3. Temperature measurement can be carried out when necessary, which can be skipped usually. Temperature and humidity values that are measured with an external thermometer and hygrometer can also be entered into the tester.

⚠ Tips

- Note 1: If the measurement stops before the first time interval, then log-recorded data will not be obtained, while data number will be displayed.
- Note 2: If LobAt is displayed and the data number is flashing after a measurement, it indicates that either the battery power is insufficient or power is turned off, and data will be saved.

5.1.2.5 Saving data to the memory

Procedures

Push 'ENTER' button, and MEMO No. symbol will be turned off after flashing and log-recorded data will be saved in the memory. In case the memory is damaged, 'Err' will be displayed on LCD with 3 warning beeps, and then 'Err' will disappear after 1 second.

⚠ Tips

- Note 1: The tester cannot record the following data: ambient temperature under which insulation resistance measurement is carried out, the external voltage during a voltage measurement, and the leak current data which is read as resistance data.

5.2 Reviewing recorded data

5.2.1 Operation procedures

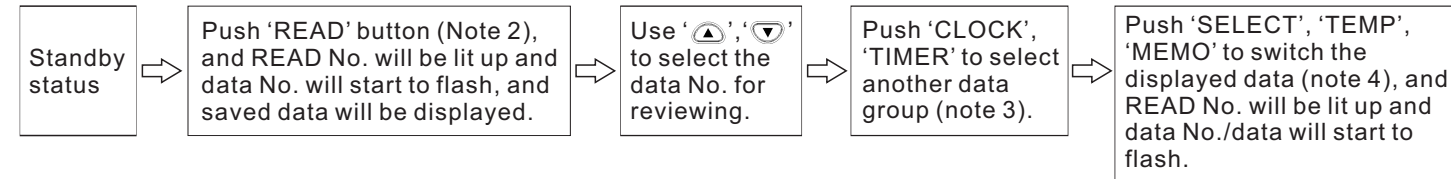

⚠ Tips

Note 1: Manually-saved data can be reviewed on screen; For log-recorded data, only the last data can be reviewed on screen, while all records can be reviewed on PC with the PC software.

Note 2: Push READ button under the mode of standby (MEMO No. symbol must be turned off)

Note 3: Push READ button, and 'no' will be displayed at the lower right corner if there is no data in the memory, which will automatically disappear after 1 second.

5.2.2 Mode of displaying for recorded data

The following are the displaying modes for recorded data

1. If the data number does not begin with Lr, then it is manually-recorded data;
2. If the data number begins with Lr, then it is log-recorded data;
3. The types of manually-recorded data are listed below:
 - 1) If neither 'STEP' nor 'TC' is displayed, then it is standard test data.
 - 2) If 'TC' is displayed, then it is temperature compensation data.
 - 3) If 'STEP' is displayed, then it is step-voltage measurement data.

5.2.3 Reviewing recorded data

The recorded data can be categorized into standard test data, temperature compensation data, and step-voltage measurement data; A lot of data are not directly displayed on screen, and therefore you need to push 'SELECT' button to switch the display in order to review data that is not on display.

5.2.3.1 Reviewing standard test data

For standard test data, the switching buttons are listed below in the table:

Displayed values for switching	Button used
For manually-recorded: Insulation resistance, leak current, DAR 1 min/15 s, DAR 1 min/30 s, PI (10/1 min); For log-recorded: insulation resistance, leak current.	SELECT
Time spent, temperature and humidity	TEMP
Date of test, time of test, data	MEMO
Return to standby mode	READ
The set testing voltage, actual output voltage	▲

5.2.3.2 Reviewing temperature compensation data

For temperature compensation data, the switching buttons are listed below in the table:

Displayed values for switching	Button used
Insulation resistance after compensation, leak current without compensation	SELECT
Time spent, actual measured temperature, reference temperature	SELECT
Date of test, time of test, data	MEMO
Return to standby mode	READ
The set testing voltage, actual output voltage	▲
Resistance before compensation, resistance after compensation	TC
Actual measured temperature / humidity, reference temperature / temperature compensation table number	TC

5.2.3.3 Reviewing step-voltage measurement data



There are two displaying modes for step-voltage measurement data: typical data display and detailed data display; the differences between these two modes are listed below in the table:

Display mode	Displayed data	Symbol
Typical data display	The test data in the last step	HOLD is not displayed
Detailed data display	Test data in every step	HOLD is flashing

5.2.3.3.1 Mode of typical data display

When displaying step-voltage measurement data, the test data in the last step is displayed first under the mode of typical data display.



Switch the displayed data according to the descriptions below in the table.

Displayed values for switching	Button used
Time spent, temperature / humidity	TEMP
Date of test, time of test, data	MEMO
Accessing the mode of detailed data display	SELECT
Return to standby mode	READ
The set voltage, actual output voltage	 

5.2.3.3.2 Mode of detailed data display

Push 'SELECT' button under the mode of typical data display, and HOLD symbol will start flashing and the display mode will be switched to the mode of detailed data display, and then it will display data on screen starting from the test data in the first step.

Switch the displayed data according to the descriptions below in the table.

Displayed values for switching	Button used
Switch to the test data in another step	 
Insulation resistance value, leak current	TIMER, CLOCK
Time spent in every step, temperature / humidity	TEMP
Date of test, time of test, test data	MEMO
Return to the mode of typical data display	SELECT
Return to standby display mode	READ
The set voltage, actual output voltage	

⚠ Tips

Note 1: Temperature, humidity, date and time can be reviewed under both display modes.

Note 2: Data of leak current cannot be saved in the memory, which is calculated with voltage value and resistance value; the calculated value might differ from the value before saving by 1 %; when the resistance is 0, it will display "----".

5.3 Deleting data

5.3.1 Delete specified data

Operation procedures

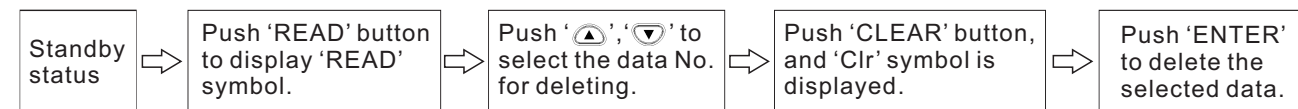

⚠ Tips

Note 1: If 'READ' button is pushed instead of 'ENTER' button, data will not be deleted and the system will directly return to the previous interface.

5.3.2 Deleting all data

Delete all manually-saved records and log-records.

Procedures



⚠ Tips

Note 1: If 'READ' button is pushed instead of 'ENTER' button, data will not be deleted and the system will directly return to the previous interface.

6. Other Functions

6.1 Changing and checking the time interval for calculating PI

User can define and set the two time intervals that are needed for displaying PI value. You can choose from 1 minute to 30 minutes, while the default settings are: t1 = 1 min, t2 = 10 min.

6.1.1 Changing the settings for time intervals

Operation procedures

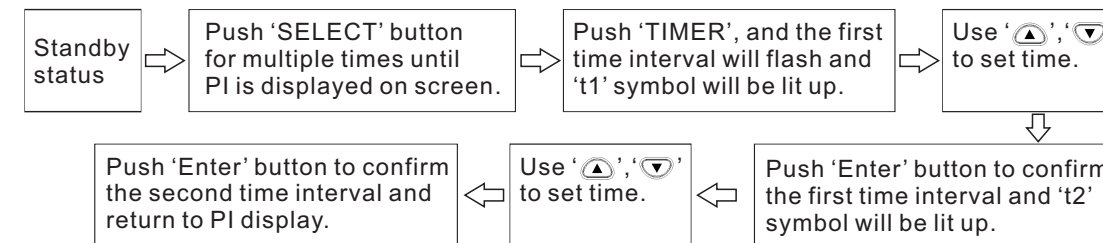

⚠ Tips

Note 1: Use '▲', '▼' button to set the time, where the second time interval must be greater than the first one.

Note 2: If the time interval is not the default value, then 10 / 1 min will not be displayed during PI displaying; Under this situation, the measured insulation resistance value is used to calculate PI at the set time intervals.

Note 3: After the time intervals are changed, the measured PI values cannot be changed.

Note 4: If 'CLOCK' button is pushed during parameter-setting, the set parameters will not be changed and the system will return to the standby mode.

Note 5: Time intervals can also be set via the communication software that is installed on a PC.

6.1.2 Checking the settings for time intervals

Operation procedures

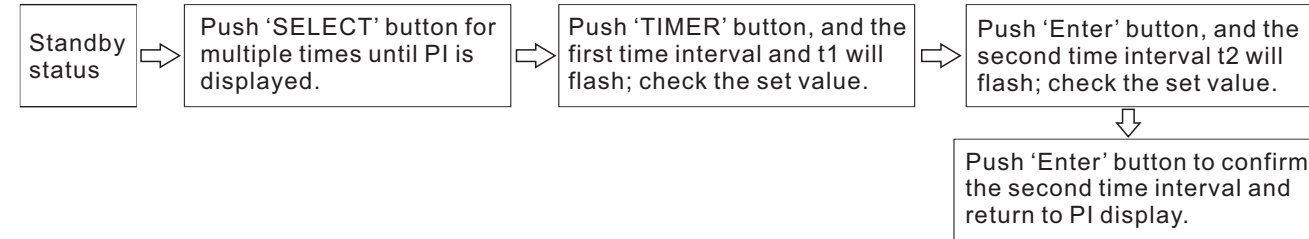

6.2 Changing and checking the applied time for step-voltage test

When changing the voltage-applying time for each step in step-voltage test, you can choose from: 30 seconds, 1 minute, 2 minutes, and 5 minutes.

⚠ Tips

Note 1: The set applied time for the voltage is the voltage application time in each step, rather than the total time in all the five steps.

6.2.1 Changing the settings for time

procedures

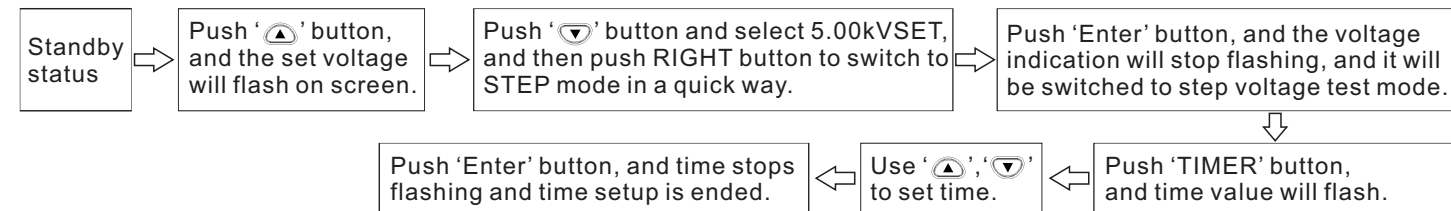

⚠ Tips

Note 1: The set applied time for the voltage is the voltage application time in each step, rather than the total time in all the five steps.

6.2.2 Checking the settings for time

1. Push '▼' button under the mode of standby, and the voltage indication starts flashing.
2. Select a mode of step-voltage measurement (STEP 2.50 kV SET or STEP 5.00 kV SET) and push 'ENTER' button, and then the time for every step will be displayed.

6.3 Entering temperature/humidity values measured with external thermometer/hygrometer

1. Application: Enter temperature and humidity values that are measured with an external thermometer / hygrometer to replace the temperature values measured with the tester.
2. Method: Before entering data, take off the temperature sensor; after entering temperature and humidity values, use SAVE function to save the data.
3. Input range: for temperature, -10.0 to 70.0 °C; for humidity, 0.0 to 99.9 RH.

Operation procedures

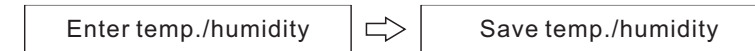

6.3.1 Entering and saving temperature and humidity values

6.3.1.1 Entering temperature and humidity values

Operation procedures

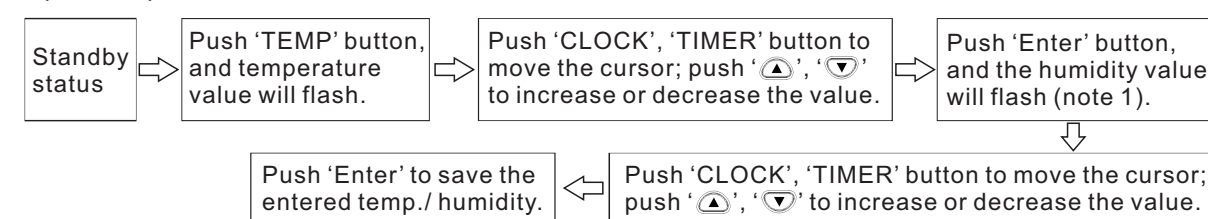

⚠ Tips

- Note 1: When TC symbol is displayed, the tester returns to standby mode and humidity value is not displayed.
 Note 2: With the temperature sensor being connected, humidity value cannot be displayed, even if the humidity value is held.
 Note 3: When values of resistance and current are held, or when it is under the mode of step-voltage measurement, temperature and humidity indication will be displayed and time value will be turned off after values of temperature and humidity are entered.
 Note 4: If 'TEMP' button is pushed with temp./humidity values flashing, system will return to standby mode.

6.3.1.2 Saving data of temperature and humidity to the memory

procedures

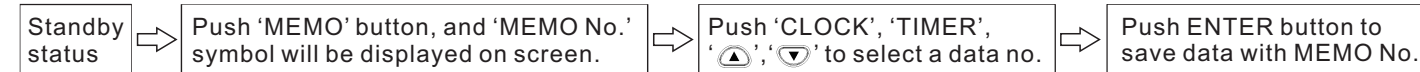

⚠ Tips

Note: When only temperature data and humidity data are saved, they are saved as standard data. Resistance value, voltage data and other data are saved as ---.

6.3.2 Clearing the indication for saving temperature/humidity data.

Clear 'TEMP HOLD' symbol and temperature/humidity data according to the following procedures:

Operation Procedures

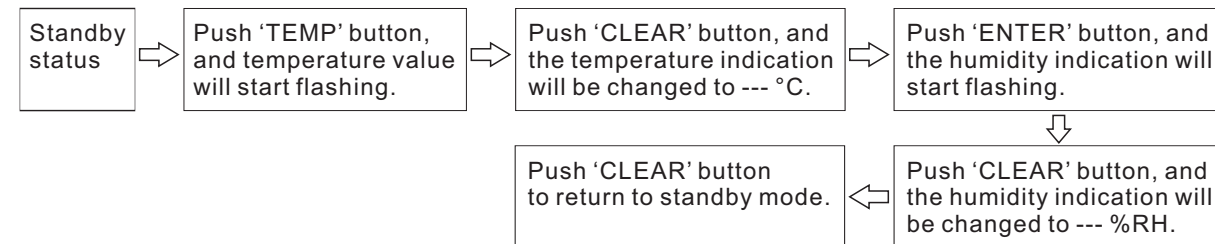

⚠ Tips

- Note 1: If the temperature sensor is connected, please take it off before doing anything else.
 Note 2: Only the displayed temperature/humidity values are cleared in the above procedures, while data in the memory are not cleared.

6.4 Communicating with a PC

1. PC can be used to make table or curve
2. Data in the memory can be uploaded to a PC, while the internal parameters can be set with a PC.
3. Relevant software shall be installed on a PC.
4. The tester cannot carry out insulation resistance test, leak current test, or voltage test when it is communicating with a PC.
5. System requirement
 Operation system: Windows98, Windows2000, Windows XP, Windows Vista
 Hard-disk capacity: 100 MB remaining space
 Interface: USB
6. Functions of the PC software
 - 1) Obtain the saved data from the tester.
 - 2) Display the obtained data and log-record and make curves for the step-voltage measurement, and save test data.
 - 3) Set tester parameters.
7. Parameters that can be set on a PC.
 - 1) Date and time
 - 2) Time interval for calculating PI
 - 3) The applied time for step-voltage test

6.4.1 Installing the PC software

Make sure that the software is installed on the PC before connecting the tester to the PC.

Procedures

1. Double click IRT_STEPUP.EXE
2. Click "NEXT"

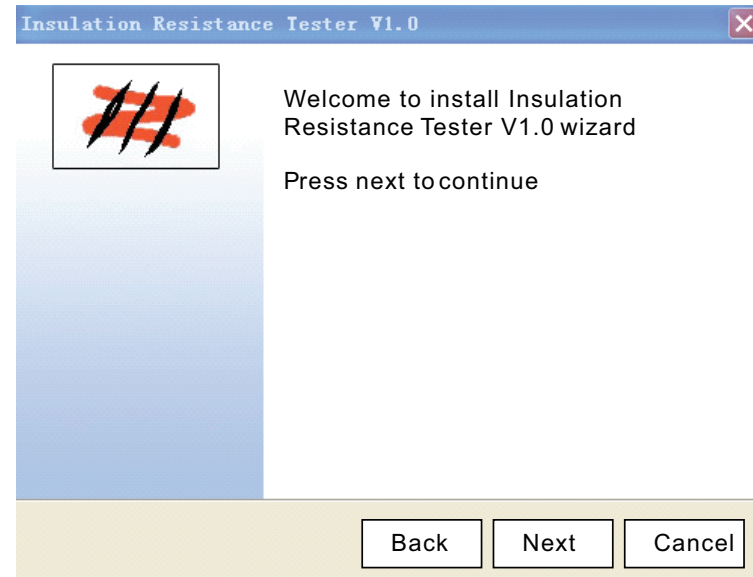

3. Select "I accept the above terms and conditions" and click "NEXT".

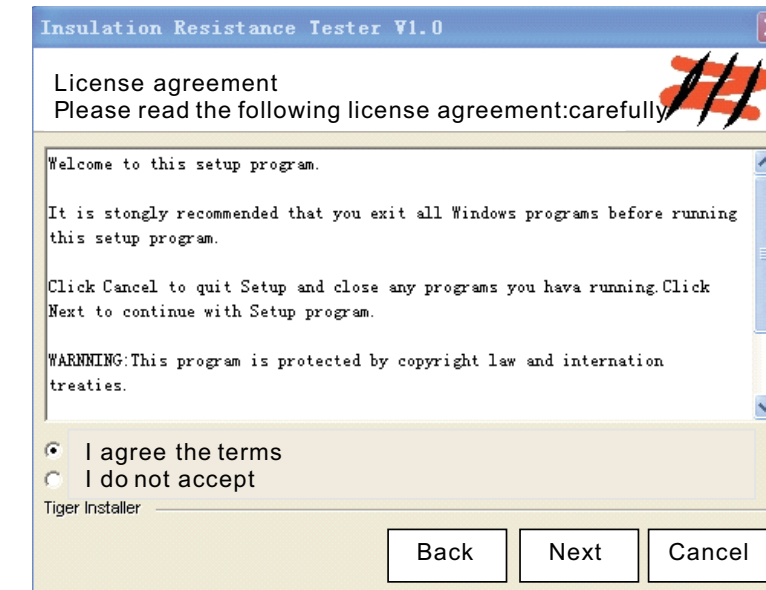

4. Choose the installation directory and click "NEXT".

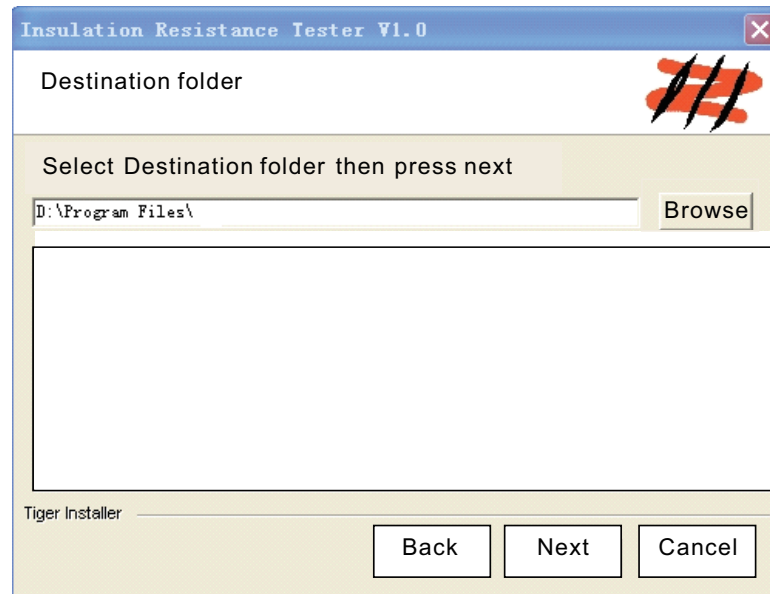

5. Click "NEXT".

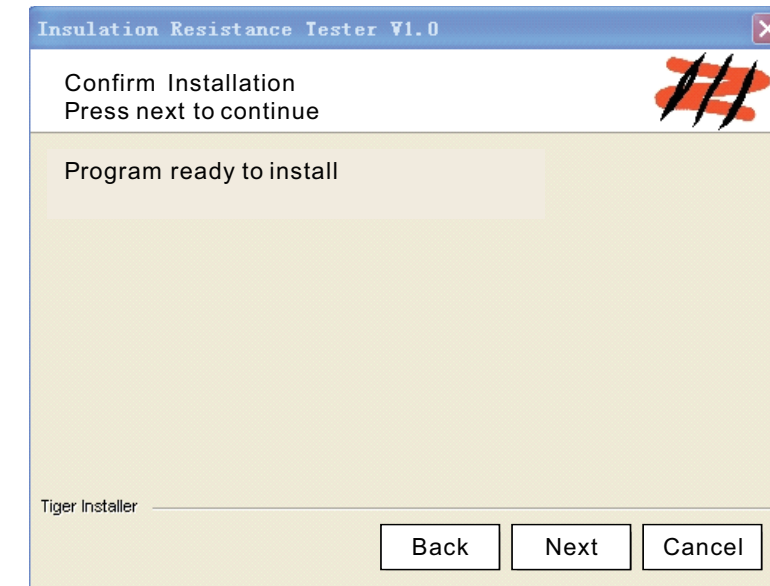

6. Start installing.

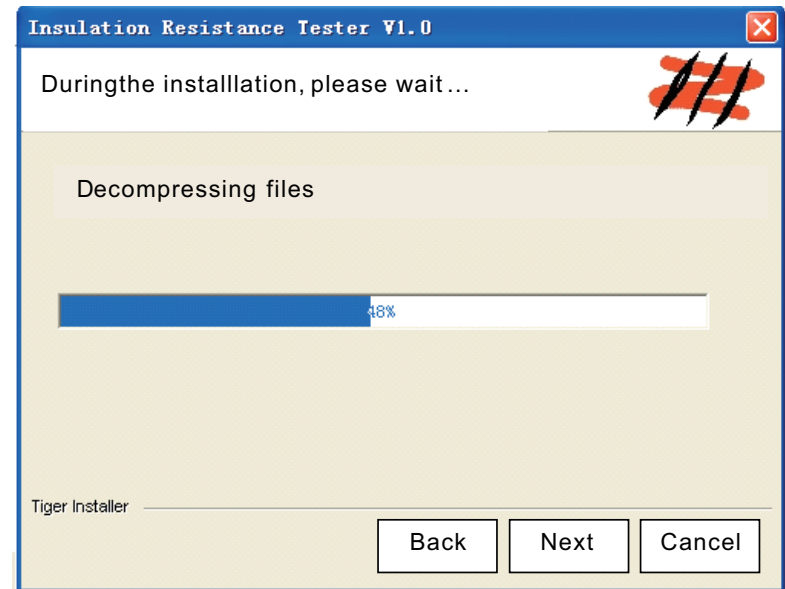

7. Click "Finish" to complete the installation.

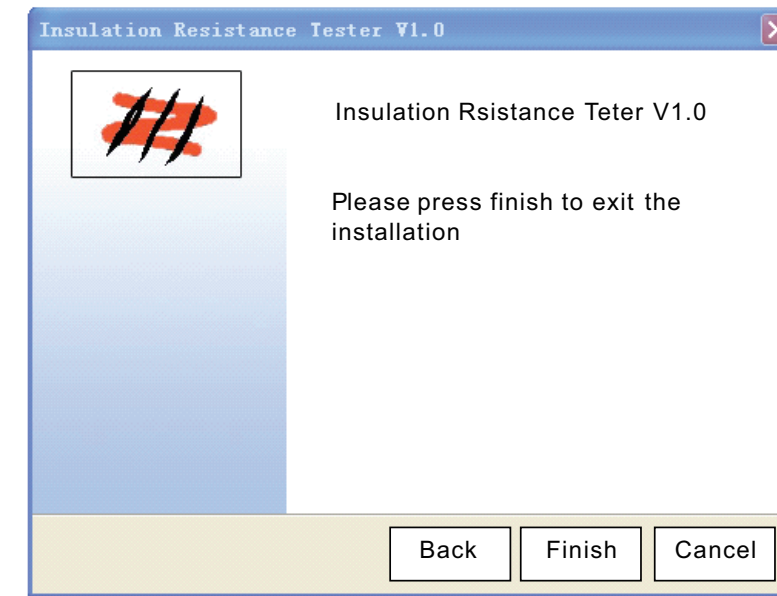

8. After installation is completed, an icon of “Insulation meter V1.0” appears on the desktop; double click on it to start it.



6.4.2 Installing driver

Driver shall be installed (under Windows XP) before connecting the tester to the PC.

Procedures

1. Turn off the tester.
2. Use the supplied USB cable to connect the tester to the PC.
3. Turn on power, and the PC will automatically detect the tester and it will display “new hardware found” on screen. If a wizard dialogue box for auto updating Windows pops up, select NO and click on ‘Next Step’ button once. This dialogue box does not pop up in certain versions of Windows XP, instead, the dialogue box that is described in the forth step pops up.
4. Choose “install from list” or “install from specified folder (advanced)”, and click ‘NEXT STEP’ once.

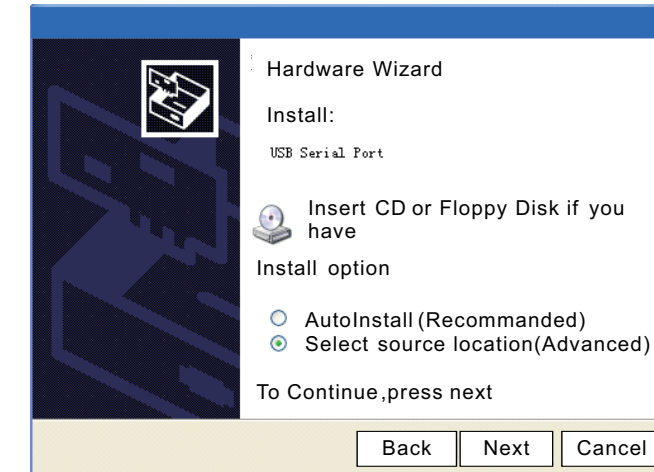

5. Insert the supplied CD into the optical driver E, and click "Browse" and then select the file "USB_DRIVER" from the CD, and then click "NEXT"

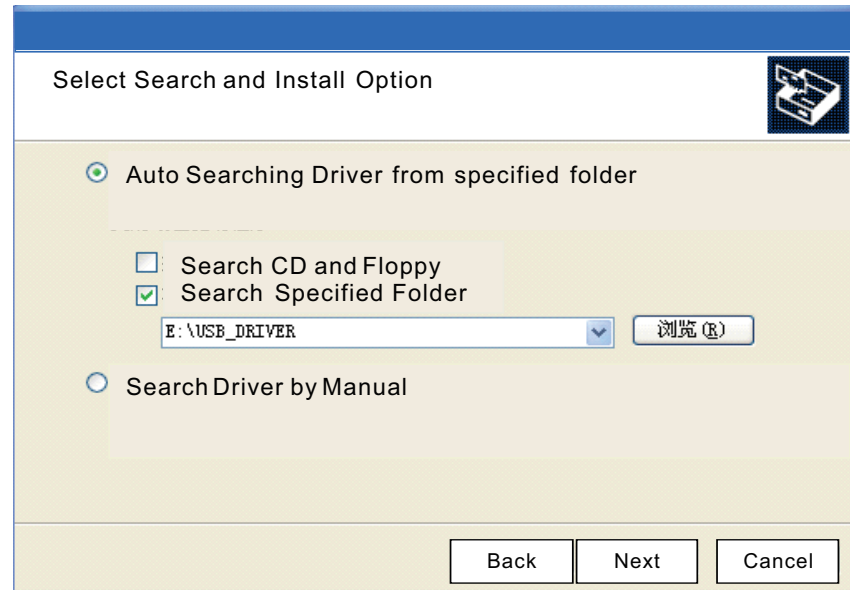

6. Auto searching

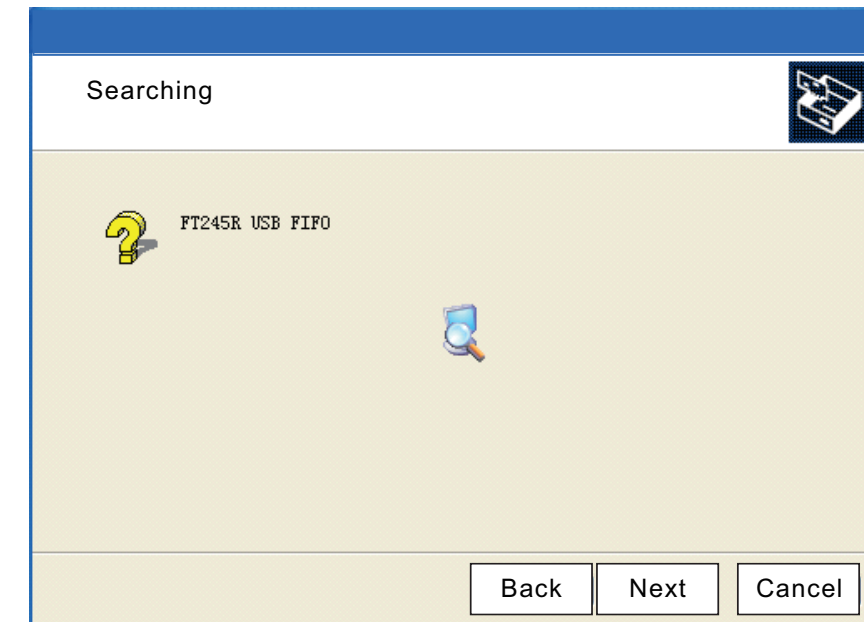

7. Click "Finish"

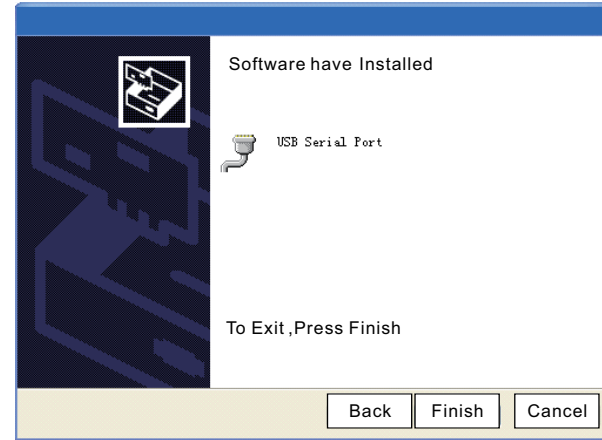

6.4.3 Downloading data to PC / Configuring the tester

Use a 2-meter or shorter USB cable to increase communication reliability.
When the tester probes are connected to the tester, please do not connect the tester to PC.

Procedures

1. Move the socket cover upward, so that the USB socket is seen.
2. Plug the standard plug of the USB cable into the USB socket on PC, and connect the USB square plug to the USB socket on the meter.
3. Run the communication software on PC.

⚠ Tips

Only one tester at a time can be connected to a PC.
During data transfer, please do not unplug the USB cable so that transfer errors can be avoided.

7. Specifications

7.1 Ordinary specifications

Table 1:

Ambient temp. and humidity for test	0 - 40 °C, < 85% RH (without condensation)
Temperature for battery charging	10 - 40 °C, < 80% RH
Storage temperature and humidity	-10 - 50 °C, < 90% RH (without condensation)
Temperature and humidity for battery pack storage	-20 - 30 °C, < 80% RH (without condensation)
Operation environment	For elevation lower than 2000 m
Test method	Applying DC voltage (for measuring insulation resistance); effective value (voltage)
Display	LCD with backlight; Max. number: 999
Overflow indication	>, OF
Underflow indication	>, -OF
Frequency for updating the display	For insulation resistance / leak current: once per second (once in every four seconds if AVERAGE function is used)
Detection of output voltage	Twice per second
Voltage	Four times per second
Temperature	Once per second
Graduation bar	Twice per second

Table 2:

Terminals	1) Insulation resistance / voltage test: L(+), E(-), GUARD (GUARD terminals can only be used for insulation resistance / leak current tests). 2) Temperature sensor, USB, and charger.
Power supply	1) LR14 alkaline battery × 6; rated voltage: 1.5 V × 6 2) Battery pack, rechargeable nickel - metal hydride batteries; rated voltage: 7.2 V (for 500 times of charging)
Max. power consumption	1) 10 VA (using battery); 2) 6 VA (using rechargeable battery pack).
Max. powering time	Alkaline battery: about 9 hours; Battery pack: about 5 hours (with 5 kV-voltage generated, with terminals in an open circuit, and with backlight turned off).
Max. input voltage	750 VAC, ± 1000 VDC
Max. input frequency	70Hz
Max. rated voltage to earth	1000 Vrms (CAT III), 600 Vrms (CAT IV)
Insulation strength	6880 VAC: 15 seconds
Overload protection	1000 VAC, 1200 VDC between L(+) and E(-) terminals: 1 minute
Dimensions	About 284 mm (L)×230 mm (w)×125 mm (h)
Net Weight	About 2.5 kg (without batteries)
Applicable standards	The design is complied with DL/T 845.1-2004 EN61010-1:2001

Table 3:

Standard accessories	1. Test cable, 3 m × 3 2. Crocodile clips, ×3 3. Instruction manual, ×1 4. LR14 alkaline battery, ×6 5. USB cable, ×1 6. Temperature sensor, ×1 7. CD, ×1
Optional accessories	1. Rechargeable battery pack 2. AC charger
Interface	USB Ver 2.0, for communications with the PC software.
PC application software	1: Data transfer 2: Tester setup 3: Data output

Table 4:

Temperature compensation function
PI / DAR display function
Step-voltage measurement function
Data saving function: manual recording (100 records), log recording (10), deleting a single record, deleting all records, uploading data to PC
Temperature/humidity input function: (input range for temperature, -10.0 to 70 °C; for humidity, 0.0 to 99.9% RH).
Timer function: (time can be chosen from 30 seconds to 30 minutes)
Display of the time spent for test
Time display: (including year, month, day, hour, minute, and second)

AVERAGE function
Auto-discharging function
ALARM function
LCD backlight
Buzzer indication
COMMUNICATION function
Battery charging function
Auto powering off
SYSTEM RESET function

7.2 Test parameters

Data that can be tested: insulation resistance, leak current, voltage, and temperature.

7.2.1 Insulation resistance test

Testing voltage	1. Applicable range: 250 VDC - 5.00 kVDC 2. Methods of setting 1) Choose from preset voltages (250 V, 500 V, 1 kV, 2.5 kV, 5 kV) 2) Fine adjustment (resolution for 250 V – 1 kV: 25 V; for 1kV – 5 kV: 100 V) 3. Rated test current: 1) 250 V - 1.00 kV ----- 1 mA 2) 1.10 kV - 2.50 kV----- 0.5 mA 3) 2.60 kV - 5.00 kV-----0.25 mA
Short-circuit current	3 mA
Detection of output voltage	Range of display: 0 V – 999 V, 0.98 kV - 5.50 kV Precision: ± (5% rdg + 5 dgt)

Precision for insulation resistance:

Set test voltage	Test range	Threshold value of basic error
250 V DC	0.01 MΩ ~ 2.5 GΩ	± (5% rdg + 5 dgt)
	2.51 GΩ ~ 250 GΩ	± (20% rdg + 10 dgt)
500 V DC	0.01 MΩ ~ 5.0 GΩ	± (5% rdg + 5 dgt)
	5.01 GΩ ~ 500 GΩ	± (20% rdg + 10 dgt)
1000 V DC	0.01 MΩ ~ 10 GΩ	± (5% rdg + 5 dgt)
	10.1 GΩ ~ 500 GΩ	± (20% rdg + 10 dgt)
	501 GΩ ~ 999 GΩ	± (30% rdg + 20 dgt)
2.5 kV DC	0.01 MΩ ~ 25 GΩ	± (5% rdg + 5 dgt)
	25.1 GΩ ~ 500 GΩ	± (20% rdg + 10 dgt)
	501 GΩ ~ 999 GΩ	± (30% rdg + 20 dgt)
	1 TΩ ~ 2.5 TΩ	± (30% rdg + 40 dgt)
5 kV DC	0.01 MΩ ~ 50 GΩ	± (5% rdg + 5 dgt)
	50.1 GΩ ~ 500 GΩ	± (20% rdg + 10 dgt)
	501 GΩ ~ 999 GΩ	± (30% rdg + 20 dgt)
	1 TΩ ~ 5 TΩ	± (30% rdg + 40 dgt)

⚠ Tips

Note: Response time < 15 seconds (Time needed for attaining the specified precision for the displayed value from the start of measurement with AVERAGE function turned off).

7.2.2 Leak current test

Measuring range: 1.00 nA - 3.00 mA (auto range; see note 1)

Range	Measuring range	Threshold value of basic error
10 nA	1.00 nA ~ 9.99 nA	$\pm (15\% \text{ rdg} + 1 \text{ nA})$
100 nA	9.0 nA ~ 99.9 nA	$\pm (15\% \text{ rdg} + 5 \text{ dgt})$
1000 nA	100 nA ~ 999 nA	$\pm (2.5\% \text{ rdg} + 5 \text{ dgt})$
10 μA	0.90 μA ~ 9.99 μA	
100 μA	9.0 μA ~ 99.9 μA	
1000 μA	90 μA ~ 999 μA	
3 mA	0.90 mA ~ 3.00 mA	

⚠ Tips

Note 1: If the displayed value is less than the lower limit of each range, then precision cannot be guaranteed.

Note 2: Response time < 15 seconds (Time needed for attaining the specified precision for the displayed value from the start of measurement with AVERAGE function turned off).

Range of temp./humidity within which insulation resistance test precision is guaranteed

Range of insulation resistance	Range of humidity within which insulation resistance test precision is guaranteed	Range of temperature within which insulation resistance test precision is guaranteed
0 Ω - 100 M Ω	<85% RH(no condensation)	$23 \text{ }^\circ\text{C} \pm 5 \text{ }^\circ\text{C}$ ($73 \text{ }^\circ\text{F} \pm 9 \text{ }^\circ\text{F}$)
101 M Ω – 20 G Ω	<75% RH(no condensation)	
21 G Ω – 500 G Ω	<65% RH(no condensation)	
501 G Ω – 5 T Ω	<55% RH(no condensation)	

7.2.3 Voltage test

Test mode	DC voltage	AC voltage
Test range	$\pm (50 \text{ V} \sim 1000 \text{ V})$	50 V ~ 750 V/(50 Hz ~ 60 Hz)
Precision error	$\pm (5\% \text{ rdg} + 5 \text{ dgt})$	
Input resistance	About 10 M Ω	

⚠ Tips

Note 1: Range of temperature and humidity in which measuring precision is guaranteed: $23 \pm 5 \text{ }^\circ\text{C}$, < 90% RH (without condensation)

Note 2: Response time: less than 3 seconds.

7.2.4 Temperature test

Measuring range	Measuring precision
-10 $^\circ\text{C}$ ~ 0.1 $^\circ\text{C}$	$\pm 1.5 \text{ }^\circ\text{C}$
0.0 $^\circ\text{C}$ ~ 40.0 $^\circ\text{C}$	$\pm 1.0 \text{ }^\circ\text{C}$
40.1 $^\circ\text{C}$ ~ 70.0 $^\circ\text{C}$	$\pm 1.5 \text{ }^\circ\text{C}$

⚠ Tips

Note 1: Range of temperature and humidity in which measuring precision is guaranteed: $23 \pm 5 \text{ }^\circ\text{C}$, < 90% RH (without condensation)

Note 2: Response time: About 100 seconds. Including response time of the temperature sensor.

8. Maintenance and Repair

1. If it seems that there is a problem with the tester, please make sure that batteries have enough power and the connection of tester probes is in good condition.
2. Before mailing out the tester for service, please take off batteries and properly pack the tester to prevent damages during transportation, and describe the problem in detail; our company is not liable for any damage caused by transportation.
3. There is a button battery in the tester; please have the battery replaced in case there is a problem with date and time after powering on. If you are not a professional technician, please do not replace the internal button battery on your own; in case internal parts are replaced by yourself, the warranty will be void.
4. The rechargeable battery can be charged for about 500 times; Please replace the rechargeable battery in case the time period for continuous operation decreases significantly with a fully charged battery.

8.1 Trouble shooting

In case the tester does not function well, please first conduct checks according to the below table.

Problems	Items for check	Measures to be taken	Reference sections
Tester cannot be powered on.	Are batteries installed? Is battery power very low?	Install new batteries	
	Does polarity match for the battery?	Check polarity.	
	Are batteries charged?	Charge the rechargeable battery.	
Batteries cannot be charged.	Is the battery selection switch correctly set?	Check the position of the battery selection switch.	2.1.1 2.1.2
	Is the charger correctly attached?	Check if the charger is correctly attached?	2.1.3
Insulation	Are rechargeable batteries installed?	Install rechargeable batteries.	2.1.2
	Is there a problem with test probes?	Replace the tester probe.	-

Problems	Items for check	Measures to be taken	Reference sections
resistance value is incorrect.	Are tester probes inserted all the way in?	Insert tester probes all the way in.	2.4
	Are tester probes connected to correct terminals?	Check the terminals.	2.4
Detected voltage is very low during insulat. resist. test.	Is the resistance value very small?	The output voltage should be very low when the resistance is low.	Appendix 1
Temperature can not be measured.	Is the temperature sensor correctly installed?	Correctly install the temperature sensor.	2.5
Resistance cannot be measured under temperature compensation mode	Is temperature measured?	Measure the temperature before measuring resistance.	4.3
Communication with PC failed.	Is USB cable correctly installed?	Correctly install the USB cable.	6.4
resistance value is incorrect.	Is battery power insufficient?	Replace the battery.	2.1.1
	Are rechargeable batteries fully charged?	Charge the battery.	2.1.4
	Is GUARD terminal directly connected to the tester probe which is connected to L(+) terminal?	Check the crocodile clip on the tester probe.	3.2.1

8.2 Cleaning

Dip soft cloth in clean water or non-aggressive cleaner, and then wipe and clean the tester. Please do not use benzene type of solvent, alcohol, acetone, ether, ketone, thinner, gasoline, etc., which will cause deformation or decoloration. Finally use dry cloth to wipe and dry the tester.

8.3 Disposal

The used tester should be disposed of and the lithium battery / rechargeable battery should be removed in compliance with local laws and regulations.

⚠ Warning

In order to avoid electrical damages and malfunctions, please do not install a new lithium battery and re-use the tester.

Remove the lithium battery.

Tools: screw driver, hexagonal wrench, tweezers

1. Turn off power, and take off LR14 batteries and rechargeable batteries.
2. Take off the four screws on the back, and take off the bottom cover.
3. Take off the screws for fixing the two circuit-boards, and take out the circuit board.
Do not take off the circuit board that is closer to LCD.
4. The lithium battery is on the remaining circuit board.

Insert tweezers or other similar tools in between the battery and the battery holder, and then take off the battery.

Attached Table

Temperature Compensation Table:

Use the following tables for temperature compensation: tables 0 ~ 8 are based on Chinese standards and table 9 is based on U.S. standards.

Table 0:

Object to be tested	Oil-immersed power transformer
Applicable range of reference temperatures	-10 ~ 70 °C
Range of convertible actual temperatures under which tests are performed	-10 ~ 70 °C
Compensation equation	$R_{tref} = 1.5^{(t-tref)/10} \times R_t$ R _{tref} : resistance after compensation. R _t : resistance under t (temperature). T _{ref} : reference temperature T: the actual temperature during measurement

Table 1:

Object to be tested	Electric motor stator coils, thermoplastic materials
Applicable range of reference temperatures	5 ~ 75 °C
Range of convertible actual temperatures under which tests are performed	5 ~ 70 °C
Compensation equation	$R_{tref} = 2^{(t-tref)/10} \times R_t$ R _{tref} : resistance after compensation. R _t : resistance under t (temperature). T _{ref} : reference temperature T: the actual temperature during measurement

Table 2:

Object to be tested	Electric motor stator coils, B-type thermoplastic materials
Applicable range of reference temperatures	5 ~ 100 °C
Range of convertible actual temperatures under which tests are performed	5 ~ 70 °C
Compensation equation	$R_{tref} = 1.6^{(t-t_{ref})/10} \times R_t$ R _{tref} : resistance after compensation. R _t : resistance under t (temperature). T _{ref} : reference temperature T: the actual temperature during measurement

Object to be tested	Power supply cables
Applicable range of reference temperatures	Table 3: -5 ~ 40°C Table 4: -5 ~ 36°C Table 5: 1 ~ 40°C Table 6: 0 ~ 40°C Table 7: 0 ~ 40°C Table 8: 0 ~ 40°C
Range of convertible actual temperatures under which tests are performed	The same as in the above row
Compensation equation: for temperature conversion coefficients of power cables, see the coefficients listed in the below table.	$R_{tref} = A_t/A_{tref} \times R_t$ A _t : the actual temperature coefficient for real measurement R _{tref} : resistance after temperature compensation. R _t : resistance under t (temperature). T _{ref} : reference temperature T: the actual temperature during measurement

Temperature compensation coefficients for power cables:

Temperature (°C)	Coefficient A					
	Oil-dipped insulation cable	poly vinyl fluoride insulation cable		Normal rubber	Normal SBR rubber	Butyl rubber
		1~3 KV	6 KV			
	Table 3	Table 4	Table 5	Table 6	Table 7	Table 8
-5	0.08	0.016				
-4	0.09	0.019				
-3	0.1	0.024				
-2	0.11	0.029				
-1	0.13	0.032				
0	0.14	0.042		0.38	0.27	0.34
1	0.16	0.048	0.25	0.4	0.28	0.35
2	0.18	0.054	0.26	0.42	0.29	0.38
3	0.20	0.07	0.27	0.44	0.31	0.4
4	0.22	0.077	0.28	0.46	0.33	0.42
5	0.24	0.091	0.29	0.48	0.36	0.44
6	0.26	0.109	0.31	0.51	0.39	0.46
7	0.30	0.124	0.33	0.54	0.42	0.49
8	0.33	0.151	0.36	0.57	0.45	0.52
9	0.37	0.183	0.37	0.6	0.48	0.54
10	0.41	0.211	0.38	0.63	0.51	0.58
11	0.44	0.249	0.41	0.67	0.54	0.61

MASTECH®

Temperature (°C)	Coefficient A					
	Oil-dipped insulation cable	poly vinyl fluoride insulation cable		Normal rubber	Normal SBR rubber	Butyl rubber
		1~3 KV	6 KV			
	Table 3	Table 4	Table 5	Table 6	Table 7	Table 8
12	0.49	0.292	0.48	0.71	0.58	0.64
13	0.52	0.34	0.52	0.74	0.62	0.68
14	0.56	0.402	0.58	0.79	0.66	0.72
15	0.61	0.468	0.59	0.82	0.7	0.76
16	0.64	0.547	0.63	0.85	0.75	0.81
17	0.73	0.638	0.74	0.88	0.8	0.85
18	0.82	0.744	0.78	0.92	0.86	0.9
19	0.91	0.857	0.85	0.96	0.93	0.96
20	1	1	1	1	1	1
21	1.09	1.17	1.11	1.06	1.11	1.07
22	1.18	1.34	1.20	1.13	1.23	1.14
23	1.26	1.57	1.40	1.20	1.36	1.22
24	1.33	1.81	1.80	1.27	1.51	1.30
25	1.44	2.08	1.90	1.35	1.68	1.38
26	1.55	2.43	2.05	1.44	1.87	1.45
27	1.68	2.79	2.40	1.54	2.08	1.55
28	1.76	3.22	2.70	1.65	2.31	1.65
29	1.92	3.71	3.80	1.77	2.57	1.77

MASTECH®

Temperature (°C)	Coefficient A					
	Oil-dipped insulation cable	poly vinyl fluoride insulation cable		Normal rubber	Normal SBR rubber	Butyl rubber
		1~3 KV	6 KV			
	Table 3	Table 4	Table 5	Table 6	Table 7	Table 8
30	2.09	4.27	4.10	1.90	2.86	1.89
31	2.25	4.92	4.45	2.03	3.18	2.00
32	2.42	5.60	5.20	2.17	3.53	2.15
33	2.60	6.45	5.80	2.32	3.91	2.32
34	2.79	7.42	7.60	2.47	4.33	2.50
35	2.95	8.45	8.28	2.65	4.79	2.69
36	3.12	9.70	8.50	2.85	5.29	2.90
37	3.37		9.66	3.10	5.83	3.13
38	3.58		11.60	3.35	6.44	3.38
39	4.06		14.50	3.63	7.18	3.65
40	4.53		16.00	3.95	8.23	3.94

Table 9:

Object to be tested	Rotary machines
Applicable range of reference temperatures	20 ~ 60 °C
Range of convertible actual temperatures under which tests are performed	20 ~ 60 °C
Compensation equation	$R_{tref} = 10.5^{(t-t_{ref})/10} \times R_t$ R _{tref} : resistance after compensation. R _t : resistance under t (temperature). T _{ref} : reference temperature T: the actual temperature during measurement

